



SERVICE MANUAL

12 18 24K

LIGHT COMMERCIAL

Cassette indoor unit



42QTD012DS
42QTD018DS
42QTD024DS

Under-ceiling indoor unit



42QZL018DS
42QZL024DS

Ducted indoor unit



42QSM012DS
42QSM018DS
42QSM024DS

Universal outdoor unit



38QUS012DS
38QUS018DS
38QUS024DS

INDEX

PART1 GENERAL INFORMATION

PART1.1 DUCTED

PART1.2 CASSETTE

PART1.3 UNDERCEILING

PART1.4 OUTDOOR UNIT

PART2 ELECTRICAL DIAGRAM

PART3 TROUBLE SHOOTING

PART – 1

GENERAL INFORMATION





Part 1.1 DUCTED

Part 1.2 CASSETTE

Part 1.3 UNDER-CEILING

Part 1.4 OUTDOOR UNIT

PRODUCT LINEUP

Ducted Cassette Under-ceiling CDU	42QSM012DS* 42QTD012DS* - 38QUS012DS*	42QSM018DS* 42QTD018DS* 42QZL018DS* 38QUS018DS*	42QSM024DS* 42QTD024DS* 42QZL024DS* 38QUS024DS*	42QSM036DS* 42QTD036DS* 42QZL036DS* 38QUS036DS*	42QSM048DS* 42QTD048DS* 42QZL048DS* 38QUS048DS*	42QSM060DS* 42QTD060DS* 42QZL060DS* 38QUS060DS*
Ducted	 700x635x210	 920x635x210	 920x635x270	 1200x865x300		
Cassette	 570x570x260		 840x840x245		 840x840x287	
Under-ceiling	-	 1068x675x235		 1650x675x235		
CDU	 810x310x558mm (W*D*H)		 845x320x700	 945x395x810	 938x392x1369	

UNIT MODEL IDENTIFICATION

42	Q	U	S	018	D	S	2	*
----	---	---	---	-----	---	---	---	---

42, IDU
38, ODU

D, DC inverter

Q, Heat pump

S, Single phase
T, Three phase

U, ODU
H, High wall
S, Duct
T, Cassette
Z, Under-ceiling
F, Console
F, Floor-standing

2/3/4, Multi

Series name

Capacity (KBtu/h)

Customer Code
B, Beijer
G, Germany
N, Nordic Model
...

PART - 1

GENERAL INFORMATION

1.1 DUCT

DIMENSIONS

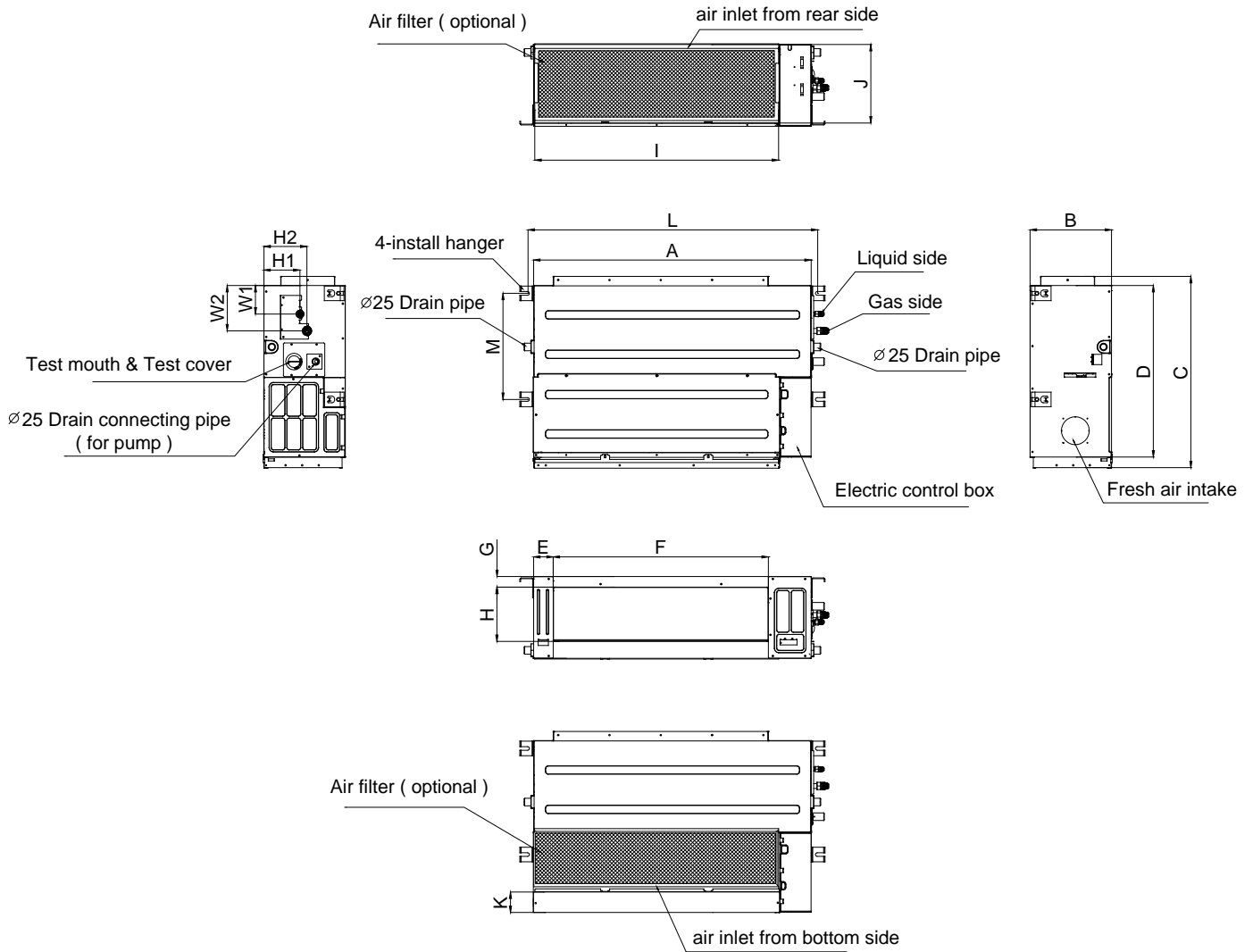

Note: standard product without filter														Unit: mm			
Model	Outline dimension(mm)				Air outlet opening size				Air return opening size			Size of install hanger		Size of refrigerant pipe			
	A	B	C	D	E	F	G	H	I	J	K	L	M	H1	H2	W1	W2
42QSM012DS*	700	210	635	570	65	493	35	119	595	200	80	740	350	120	143	95	150
42QSM018DS*	920	210	635	570	65	713	35	119	815	200	80	960	350	120	143	95	150
42QSM024DS*	920	270	635	570	65	713	35	179	815	260	20	960	350	120	143	95	150

Fresh air intake joint

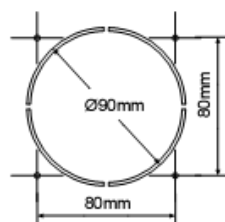



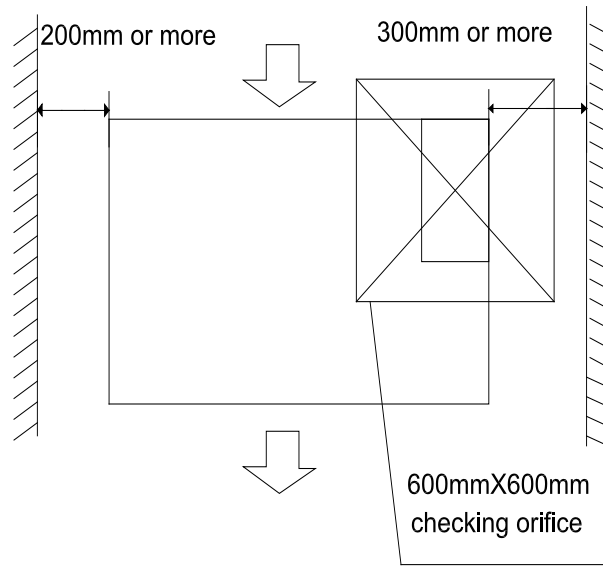

INSTALLTION SPACE



STATIC PRESSURE

2.4.4 Static pressure can be re-set by dia switch ENC2 on control board.

ENC2					
CODE	0	1	2	3	4
42QSM012	0	10	20	30	40
42QSM018/024	10	25	40	55	70
42QSM036	20	35	50	65	80
42QSM048/060	20	35	50	65	80
DEFAULT SETTING			○		

STATIC PRESSURE - 42QSM012DS

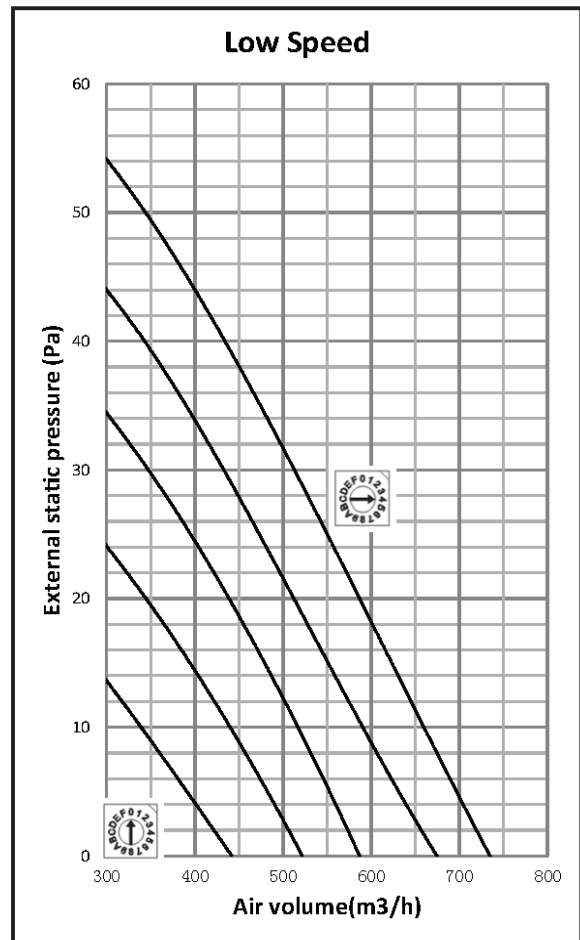
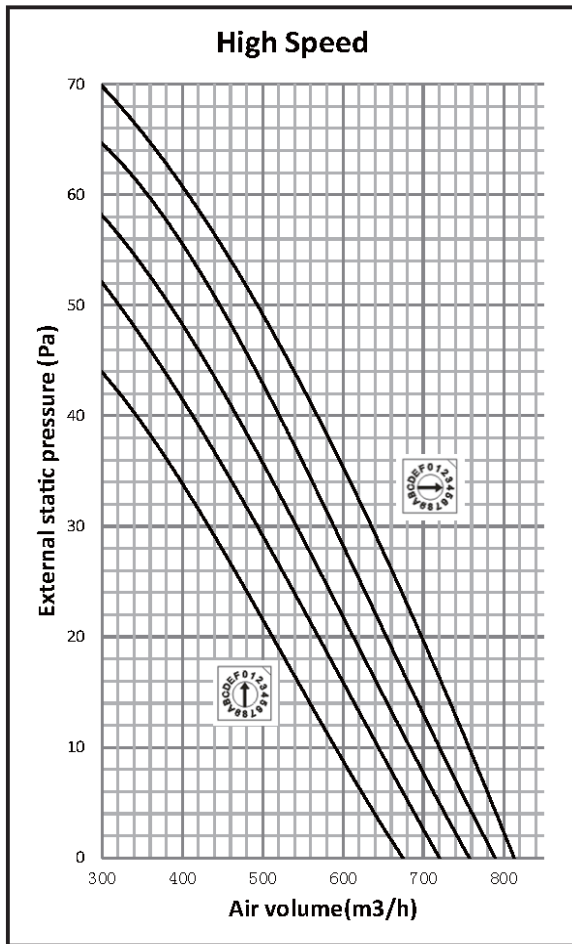

STATIC PRESSURE - 42QSM018DS

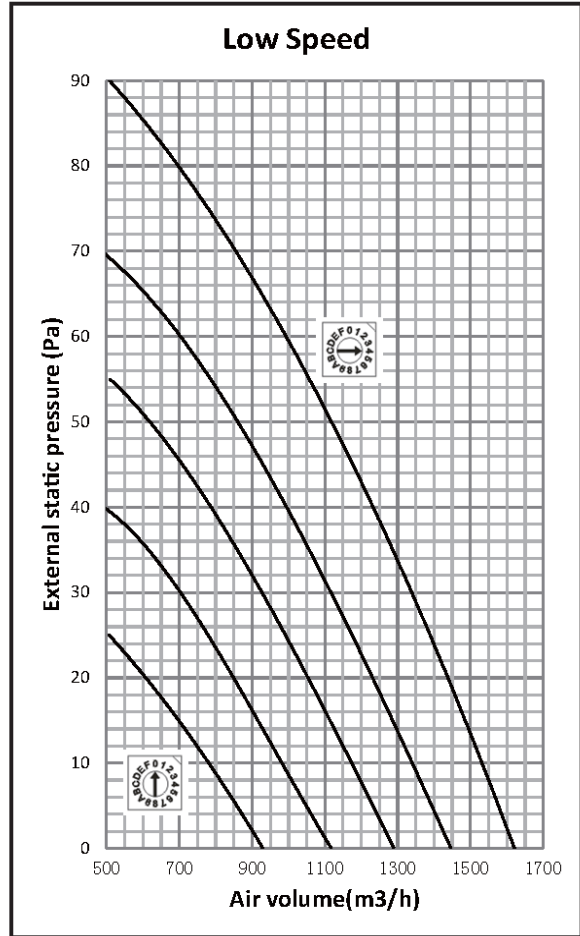
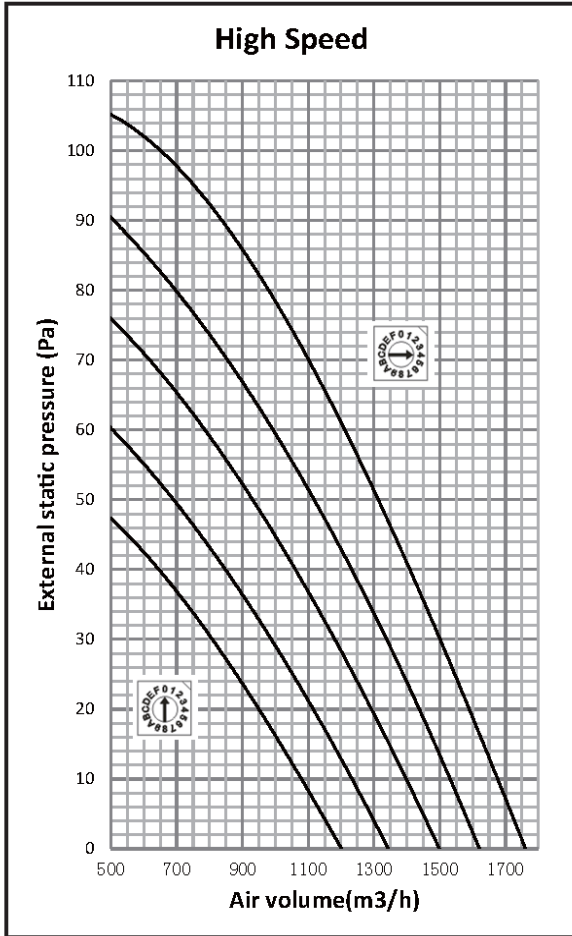

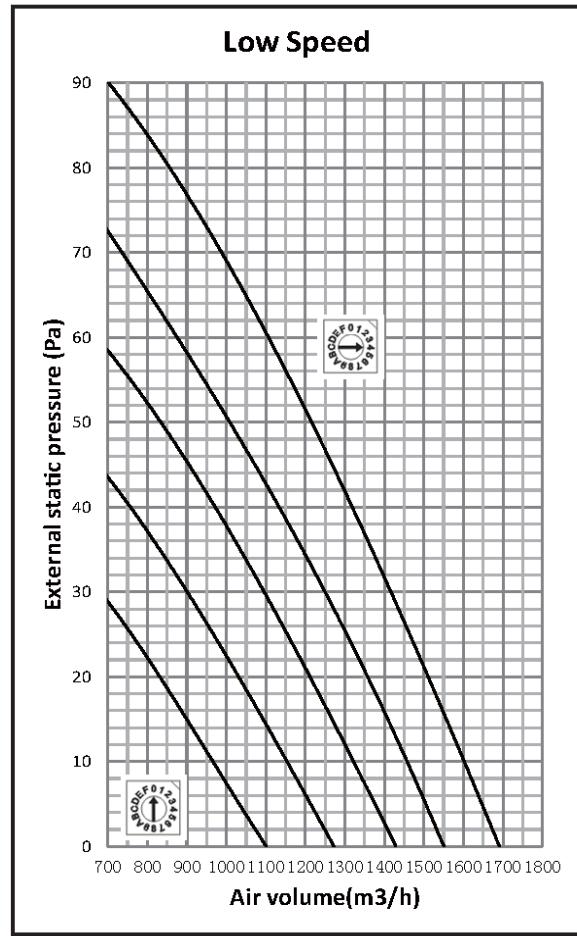
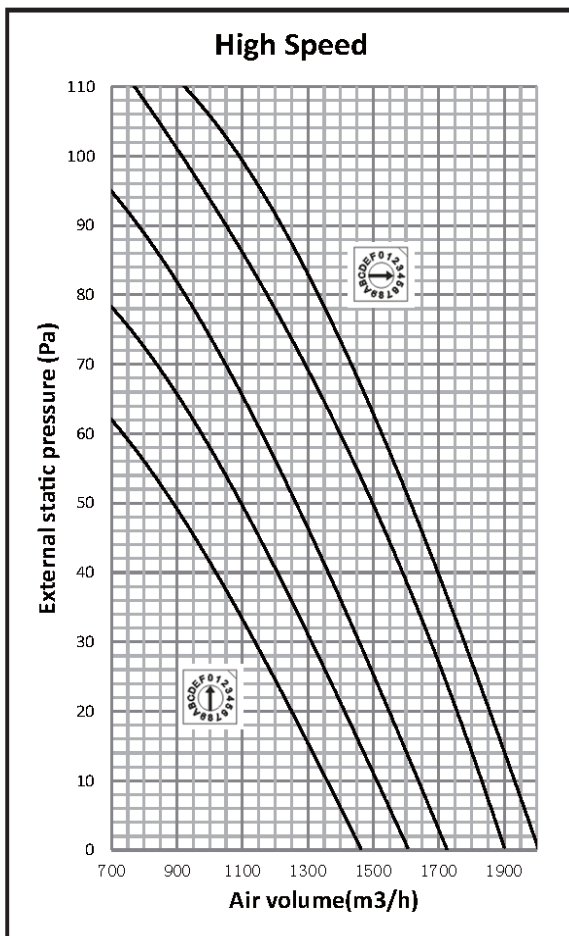

STATIC PRESSURE - 42QSM024DS

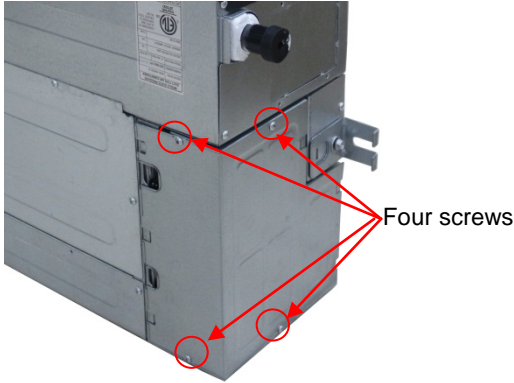
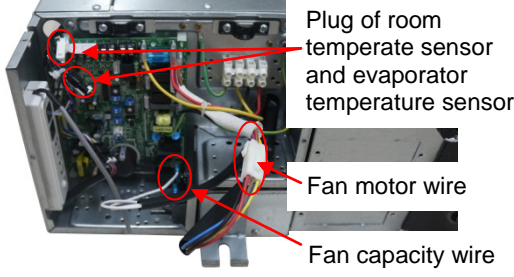
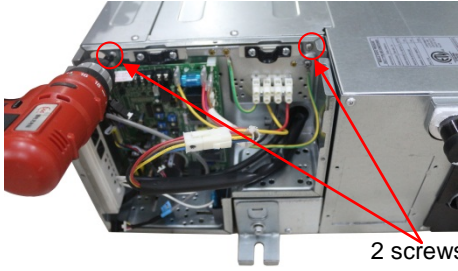
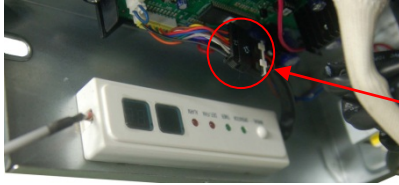
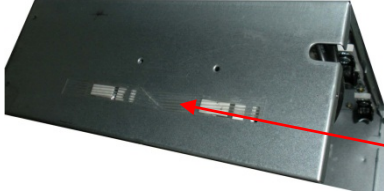
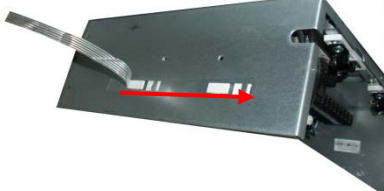

DISASSEMBLY INSTRUCTION

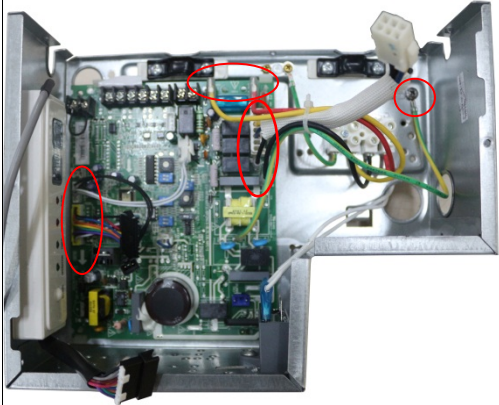
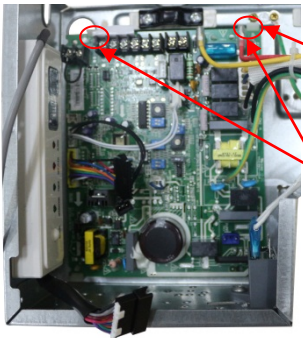
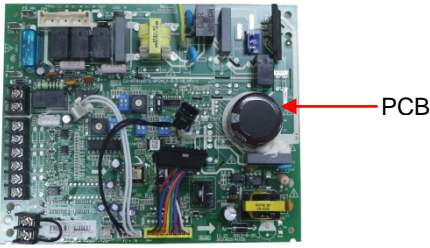
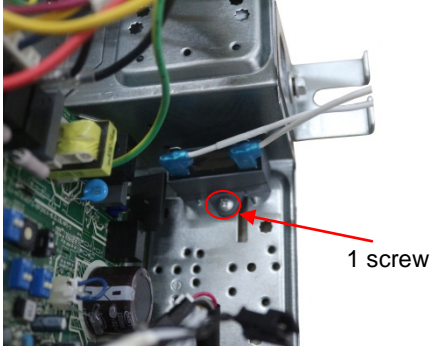
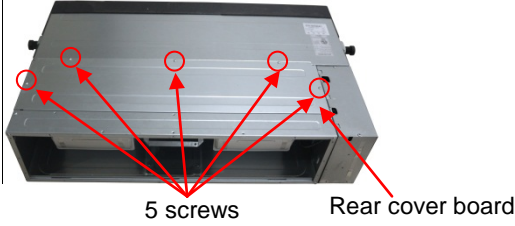
No.	Parts name	Procedures	Remarks
1	Remove the electronic control box	1) Screw off the screws to remove the cover of electronic control box	
		2) Disconnect the fan motor wire, fan capacity wire, room temperature sensor wire and evaporator temperature sensor wire	
		3) Screw off the screws to remove electronic control box	
2	Remove the display board	1) Remove the cover of electronic control box	Repeat the operation of step1 of No1
		2) Disconnect the display board wire connected to PCB	
		3) Remove the sticker	
		3) Move the display board according to the arrow direction to disassemble it.	

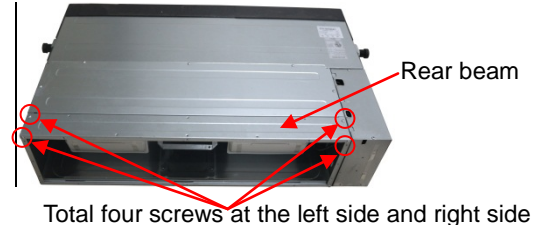
3	Remove the PCB	1) Remove the cover of electronic control box	Repeat the operation of step1 of No1
		1) Pull out all the plugs or connectors connected to the PCB and remove the ground wire after remove the screw.	
4	Remove the fan capacitor	2) Remove the PCB from the electronic control box	 <p>Press the four fixing holders from four corners to remove the PCB</p>  <p>PCB</p>
		3) Screw off the screw to remove it	 <p>1 screw</p>
5	Remove the fan motor	1) Screw off the fixing screws to remove the rear cover board	 <p>5 screws Rear cover board</p>

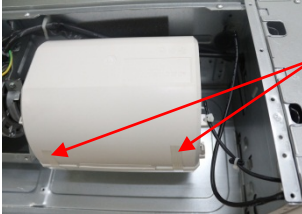
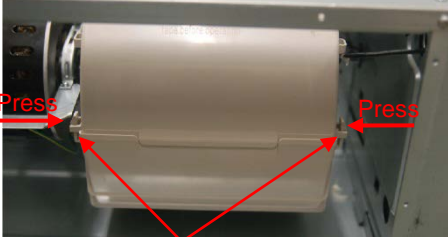
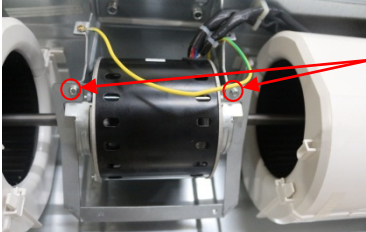
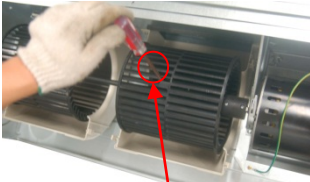
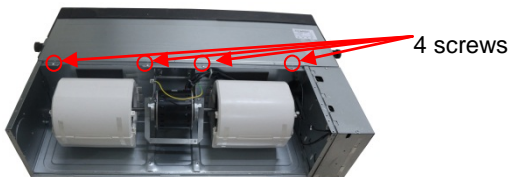
		<p>2) Screw off the fixing screws to remove the rear beam</p>	 <p>Rear beam</p> <p>Total four screws at the left side and right side</p>
		<p>3) Remove room temperature sensor</p>	 <p>Cut off the fastening belt to take off the room temperature sensor</p>
		<p>4) Remove the sticker</p>	 <p>Stickers</p>
		<p>5) Remove the below volute shell</p>	 <p>Press</p> <p>Press</p> <p>Press the clips to take off the volute shell</p>
		<p>6) Remove the fan motor wire from the electronic control box</p>	<p>Refer the operation of step2 of No.1</p>
		<p>7) Disassemble the fan motor fixing clamps to remove the fan motor assembly and fan wheel assembly</p>	 <p>The fan motor assembly and fan wheel assembly can be removed after took off the 2screws used to fix the fan motor holder.</p>
		<p>8) Disassemble the fan wheels, then you can remove the fan motor</p>	 <p>Take off the screw to remove the fan wheel</p>
<p>6</p>	<p>Remove the water collector assembly</p>	<p>1) Remove the rear cover board</p>	<p>Repeat the operation of step1 of No.5</p>
		<p>2) Screw off the screws to remove the water collector assembly</p>	 <p>4 screws</p>

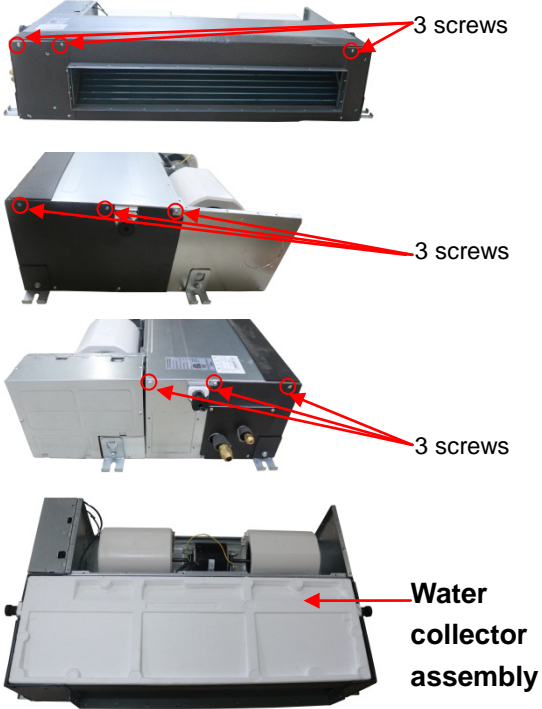
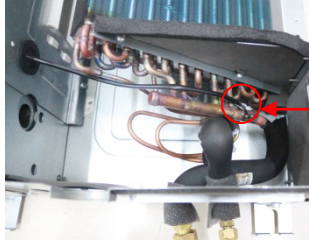
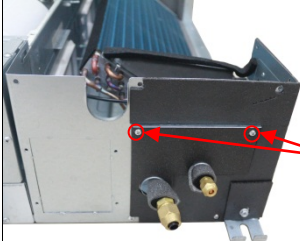
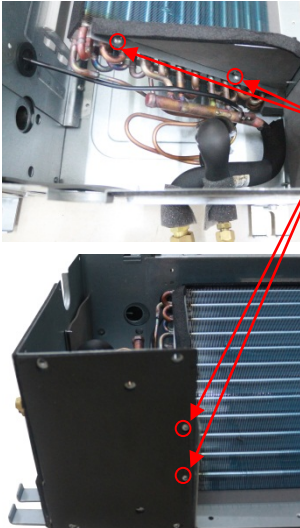
			 <p>3 screws</p> <p>3 screws</p> <p>3 screws</p> <p>Water collector assembly</p>
7	Remove the evaporator	<p>1) Remove the water collector</p> <p>2) Remove the evaporator sensor</p> <p>3) Remove the pipe clamp board</p> <p>4) Remove the evaporator support board</p>	<p>Repeat the operation of No.6</p>  <p>Evaporator sensor</p>  <p>2 screws</p>  <p>4 screws</p>

5) Screw off the fixing screws to remove the evaporator

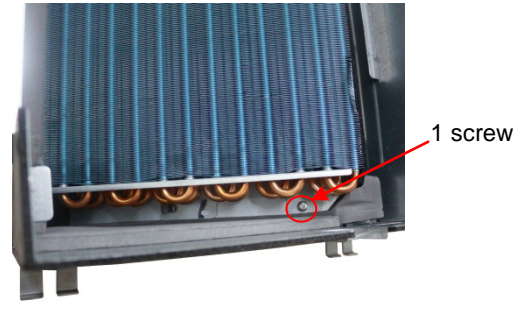

PART - 1

GENERAL INFORMATION

1.2 CASEETTE

DIMENSIONS - 12 18K

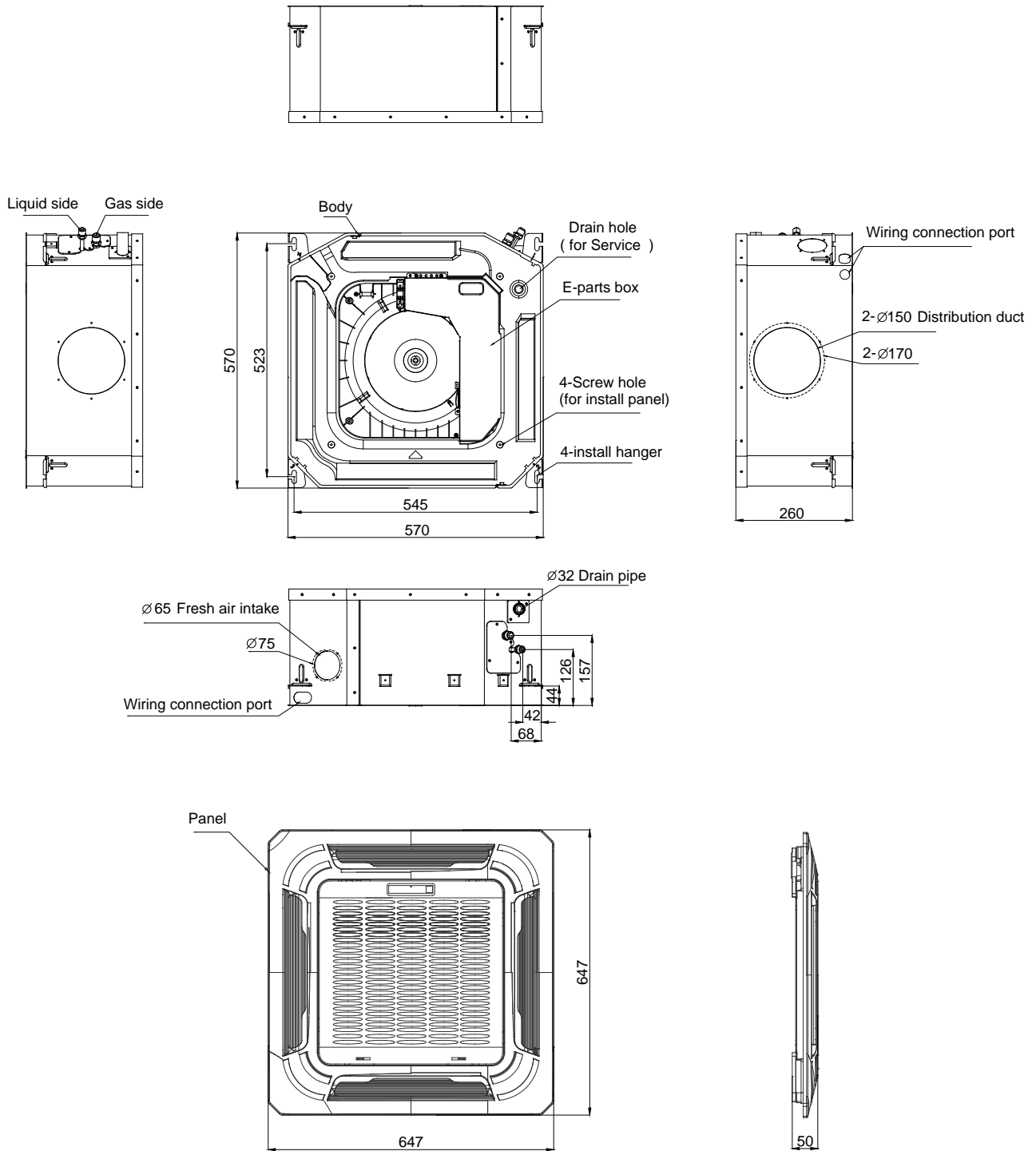

DIMENSIONS – 24K

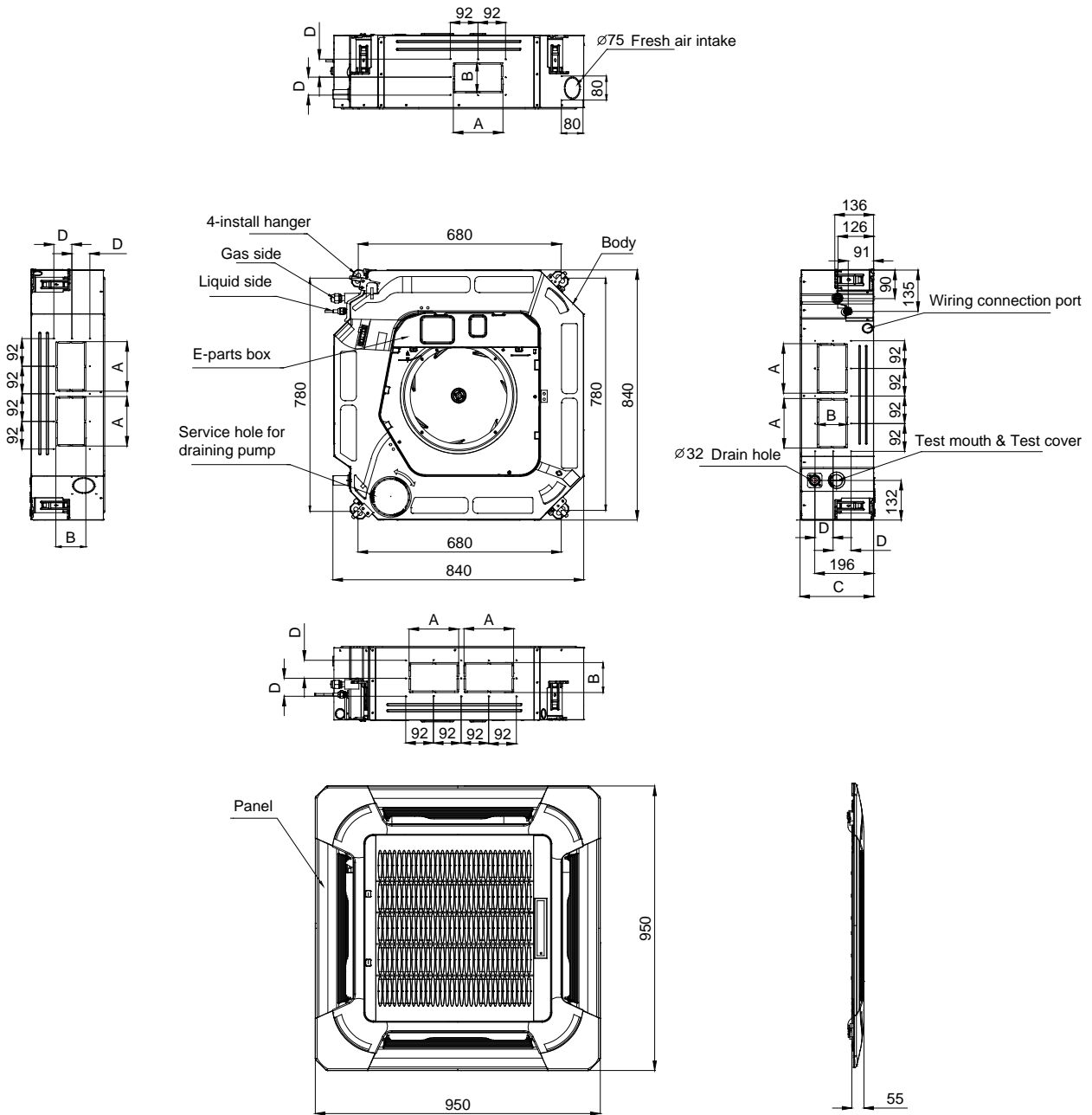

Unit: mm				
Model	A	B	C	D
42QTD024DS*	160	95	245	60

INSTALLTION SPACE

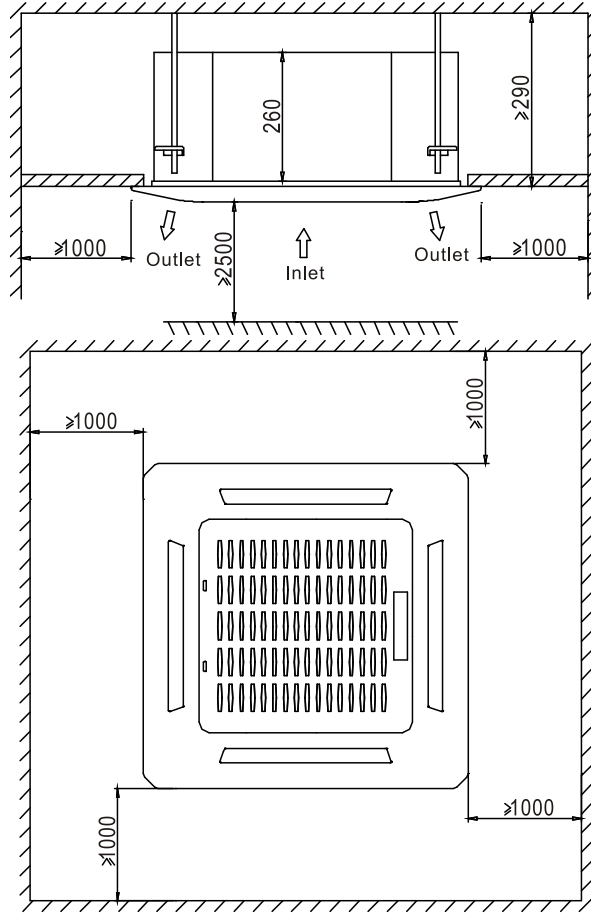



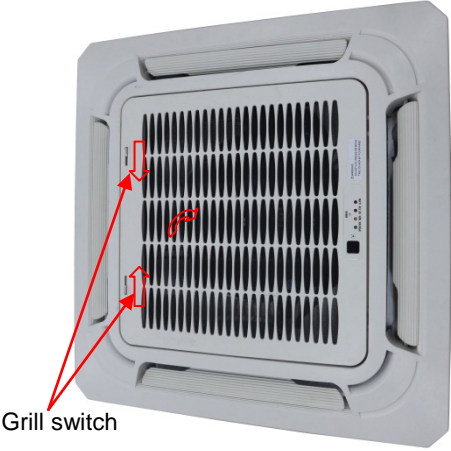
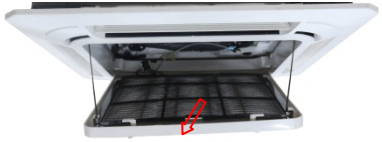
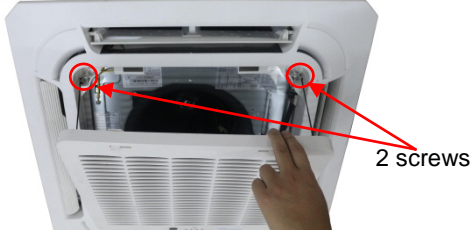
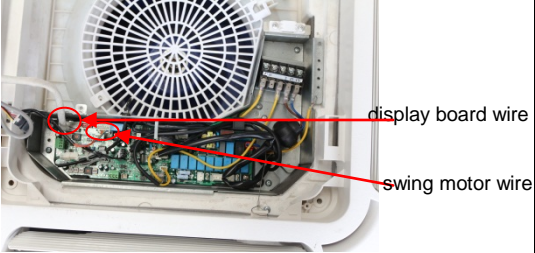
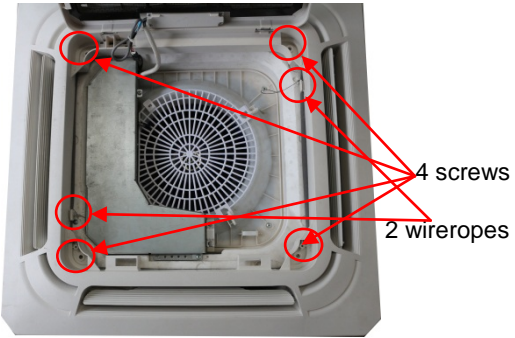

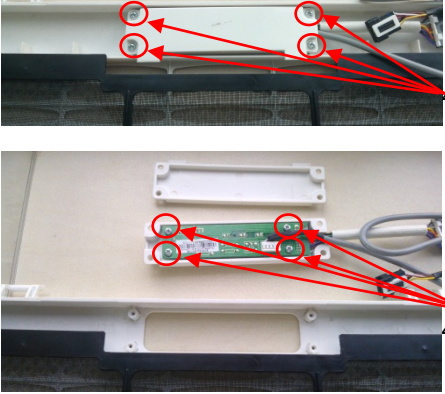
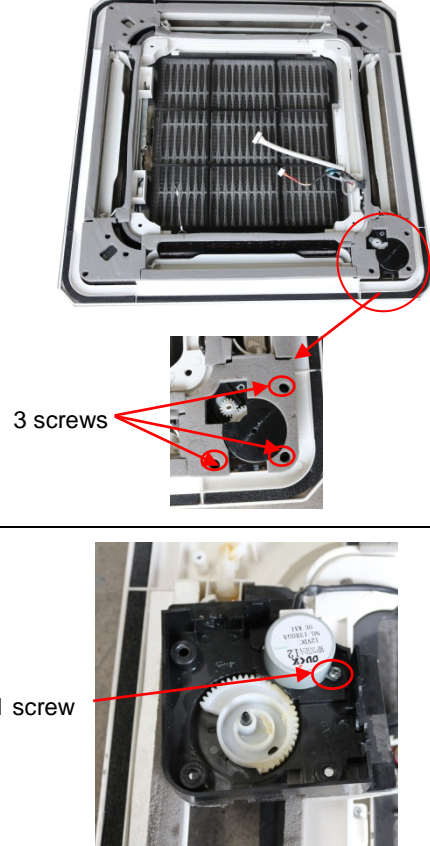
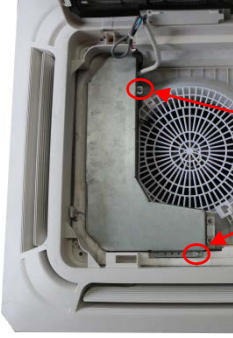
DISASSEMBLY INSTRUCTION

No.	Parts name	Procedures	Remarks
1	Remove the filter	1) Open the grille	 <p>Grill switch</p>
		2) Remove the filter Note: the filter is easy to be damaged, be careful when removing it.	
2	Remove the panel	1) Open the grille	Repeat the operation of step1 of No.1
		2) Remove the grille <ul style="list-style-type: none"> ● Screw off two screws. ● Disconnect the display board wire and swing motor wire connected to the PCB. ● Remove the grille. 	 <p>2 screws</p>  <p>display board wire swing motor wire</p>
		3) Loose the four screws and two wireropes, then the panel can be disassembled.	 <p>4 screws 2 wireropes</p>
3	Remove the display	1) Open the grille	Repeat the operation of step1 of No.1
		2) Remove the grille	Repeat the operation of step2 of No.2

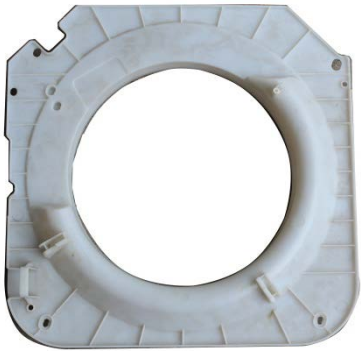
	board	<p>3) Disassemble the display board</p> <ul style="list-style-type: none"> ● Remove the display board cover(4 screws) ● Remove the display board(4 screws) 	
4	Remove the swing motor	<p>1) Remove the panel</p> <p>2) Screw off 3 screws to remove the swing motor assy.</p> <p>3) Screw off 1 screws to remove the swing motor.</p>	<p>Repeat the operation of step1,2,3 of No.2</p> 
5	Remove the PCB	<p>1) Open the grille</p> <p>2) Disassemble the electronic control box cover after remove the 2 screws.</p>	<p>Repeat the operation of step1 of No.1(No need to remove the panel)</p> 

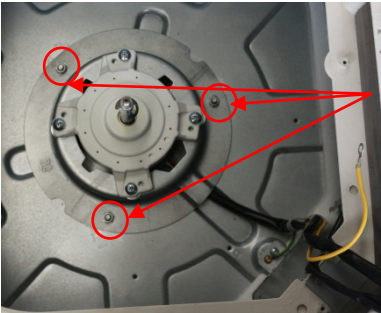
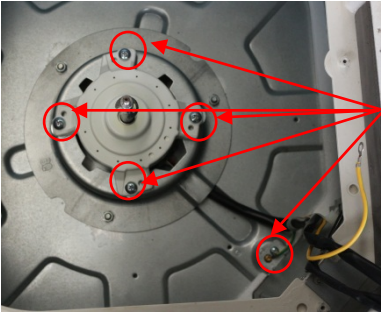
		<p>3) Pull out all the connection wires to other parts, then the PCB can be replaced.</p>	
		<p>4) There are 2 buckles fixing the PCB. To draw out the PCB, you should open them.</p>	
6	Remove the electronic control box	<p>1) Open the grille</p>	<p>Repeat the operation of step1 of No.1(No need to take down the panel)</p>
		<p>2) Remove the electronic control box cover</p>	<p>Repeat the operation of step 2 of No.5</p>
		<p>3) Pull out all the plugs or connectors connected to the electronic control box</p>	
		<p>4) Remove the electronic control box Remove the 2 screws to disassemble the electronic control box</p>	
7	Remove the fan wheel	<p>1) Repeat the operation of No.5</p>	
		<p>2) Remove the ventilation ring Release the 4 screws to disassemble it.</p>	

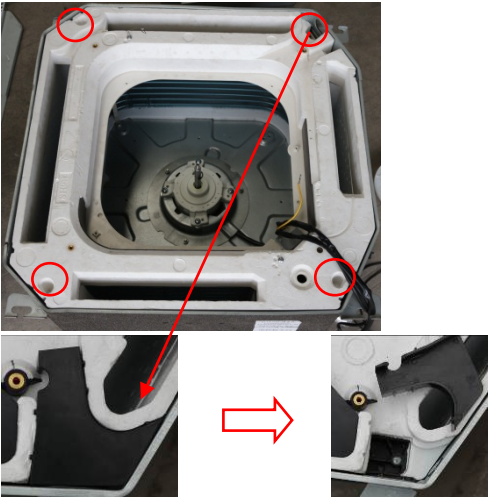
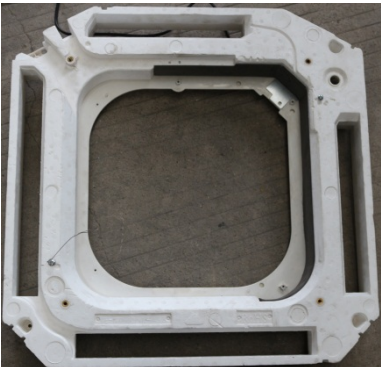
			
		3) Remove the fixing nut to disassemble the fan wheel	
		4) Pull out the fan wheel	
8	Remove the fan motor	1) Repeat the operation of No.6	
		2) Remove the fixing board of fan motor wire	
		3) Remove the 5 screws to disassemble the fan motor	
9	Remove the water collecting	1) Remove the panel	Repeat the operation of No.2
		2) Remove the electronic control box	Repeat the operation of No.6

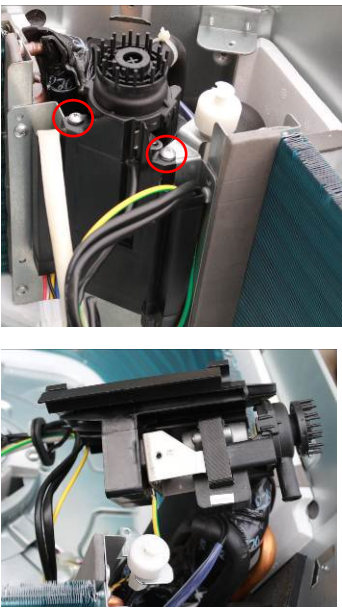
	assembly	<p>3) Screw off the 4 screws inside 4 holes (1 is under a protection cover) to remove the water collecting assembly.</p>	
		<p>4) Take out the water collecting assembly</p>	
10	Remove the draining pump	<p>1) Remove the panel</p>	Repeat the operation of No.2
		<p>2) Remove the electronic control box</p>	Repeat the operation of No.6
		<p>3) Remove the water collecting assembly</p>	Repeat the operation of No.9
		<p>4) Disconnect the drain pipe.</p>	
		<p>5) Release 2 screws to remove the pump supporter. Be careful of the connection wires.</p>	

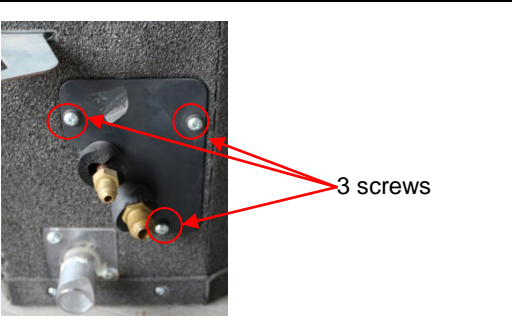
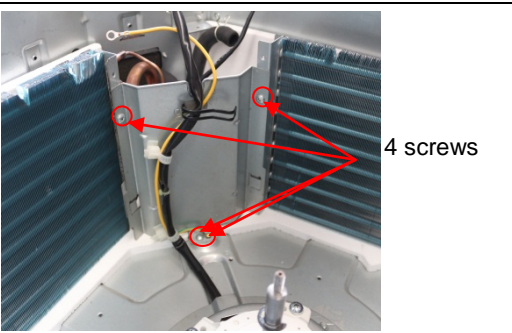
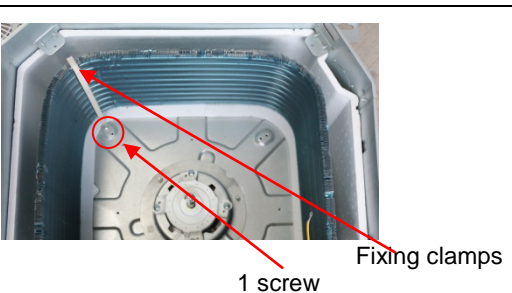

		<p>6) There are 2 screws under the supporter to fixing the pump. Release them to take the pump out of the supporter.</p>	
11	Remove the evaporator	<p>1) Remove the water collecting assembly</p>	<p>Repeat the operation of No.9</p>
		<p>2) Remove the seal board of evaporator</p>	
		<p>3) Remove the evaporator fixing board</p>	
		<p>4) Remove the evaporator fixing clamps to disassemble the evaporator.</p>	

PART - 1

GENERAL INFORMATION

1.3 UNDER-CEILING

DIMENSIONS

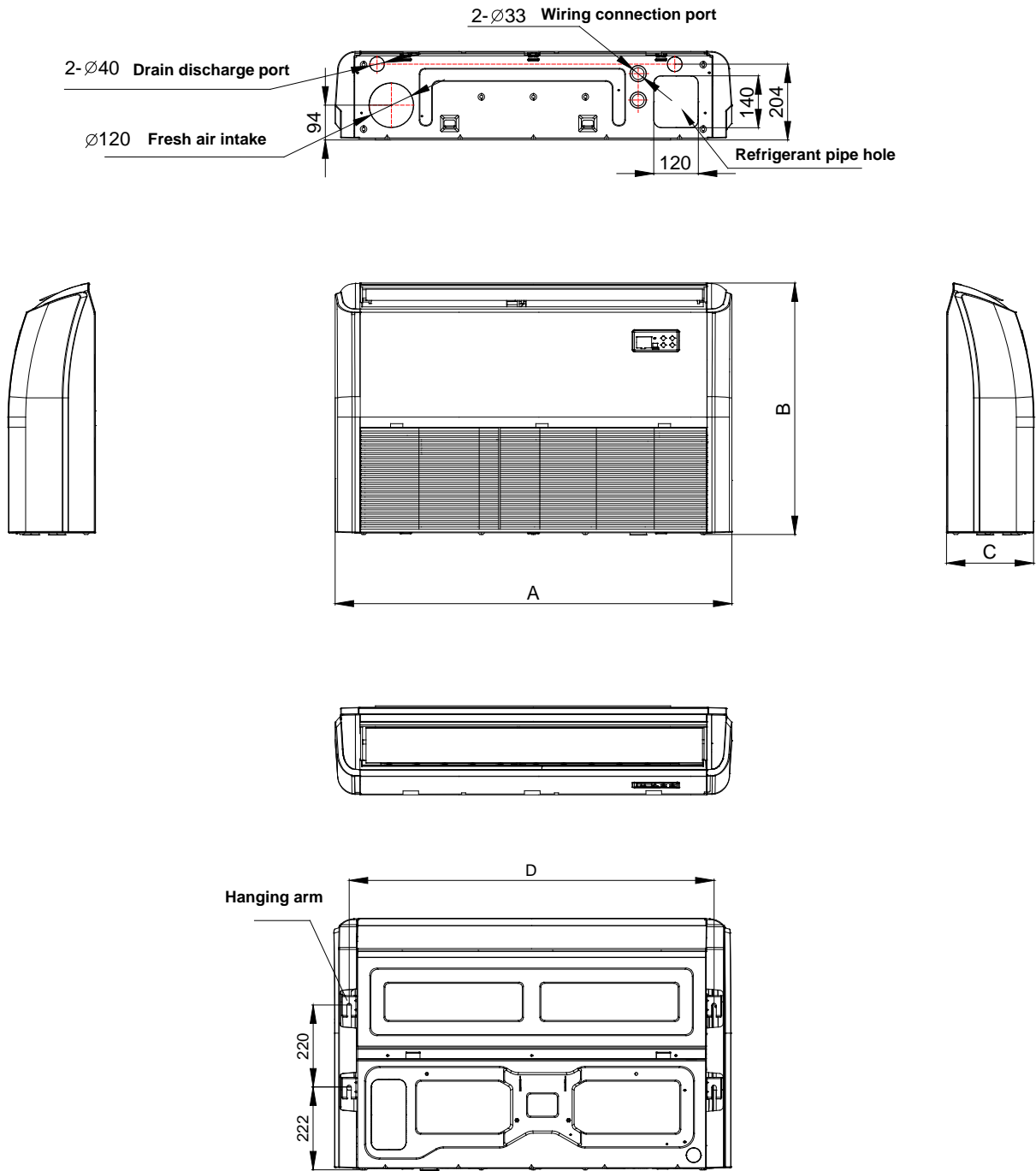

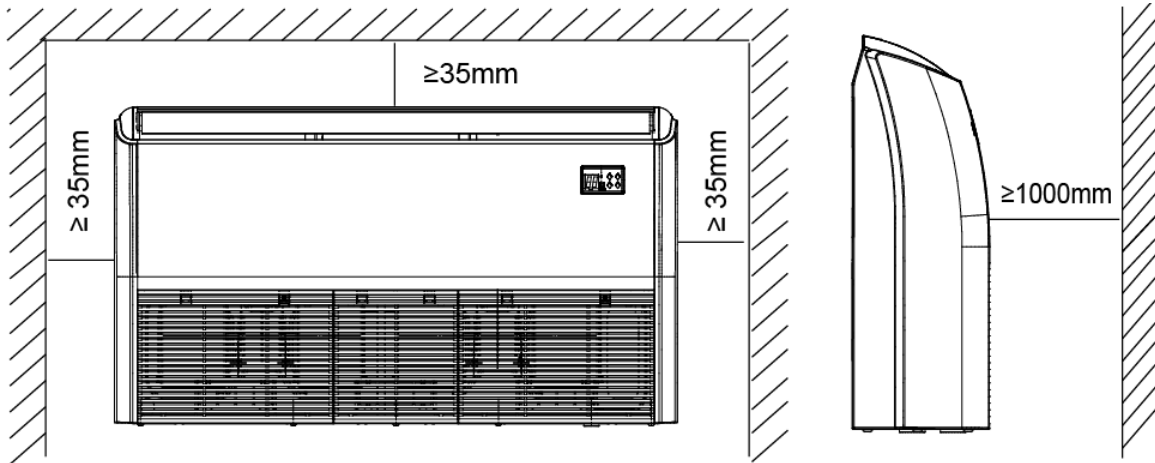

M0del	A	B	C	D
42QZL018/24DS*	1068	675	235	983

INSTALLTION SPACE

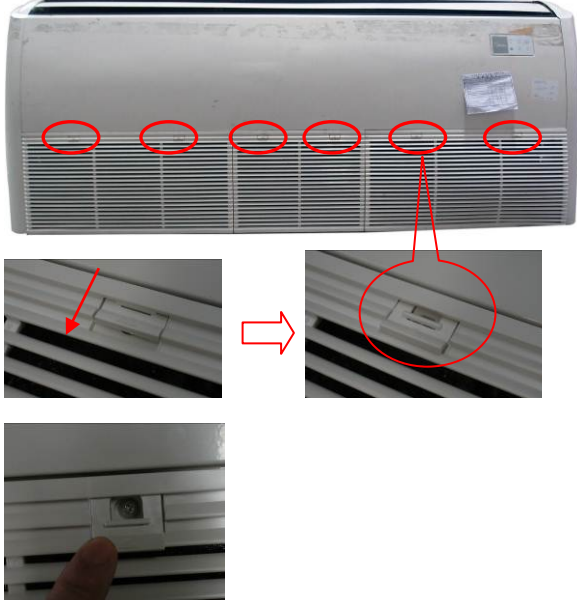
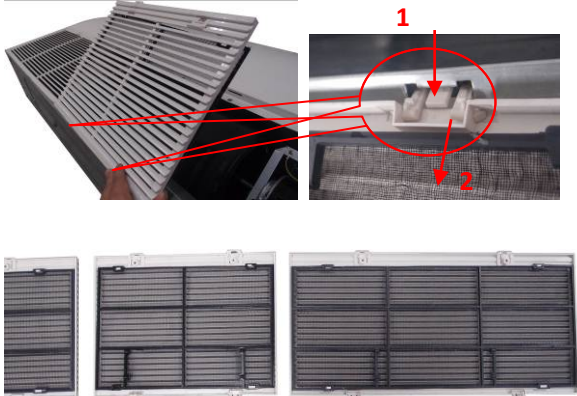
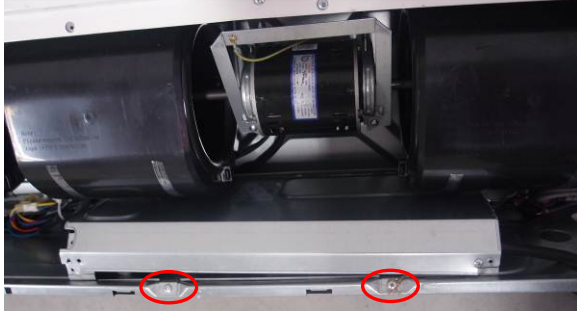

DISASSEMBLY INSTRUCTION

No.	Parts name	Procedures	Remarks
1	Remove the air outlet grilles.	1) Pull the grille locker till the screws appears, and release these screws.	
		2) Remove the air return grille (watch the lockers under the grilles).	
2	Remove the control PCB	1) Release 2 screws fixing the control box, and then take it out.	
		2) Screw off the 2 screws to remove the cover of the control box	

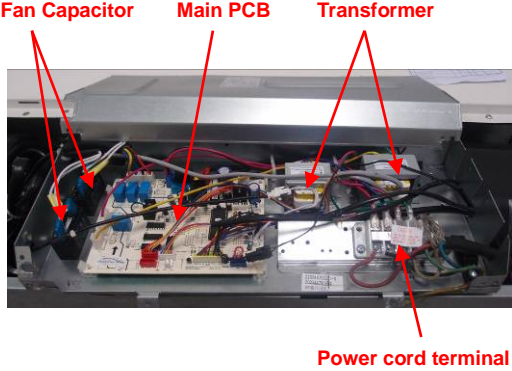
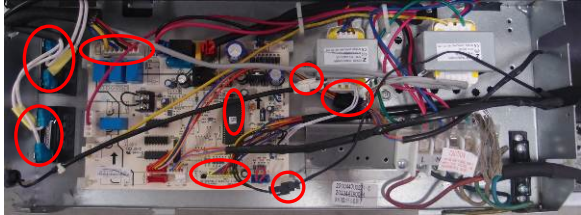
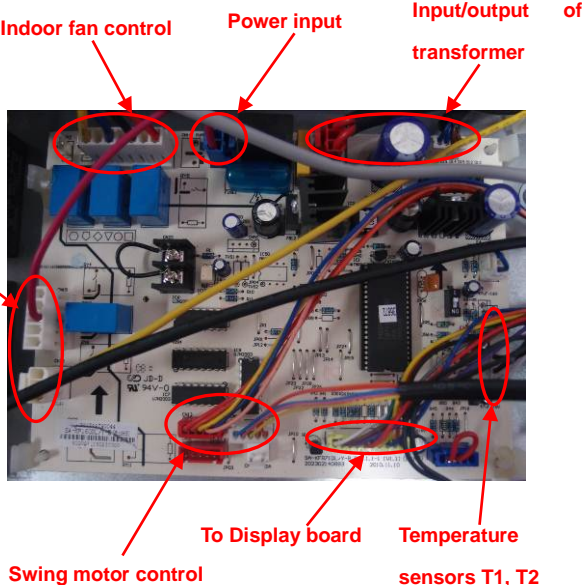
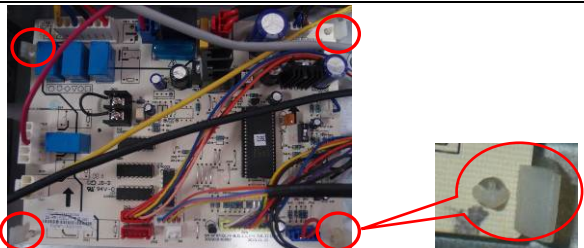
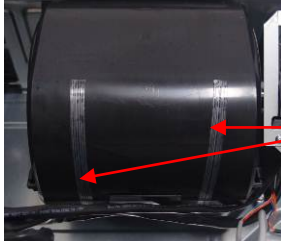
			 <p>Fan Capacitor Main PCB Transformer</p> <p>Power cord terminal</p>
		3) Disconnect the fan motor wire, louver motor wire, room temperature and evaporator temperature wire, and display board wire to remove the electronic control box	
		4) Disconnect all the wires of plugs connected to the PCB	 <p>Indoor fan control Power input Input/output of transformer</p> <p>Control wires for outdoor unit</p> <p>Swing motor control To Display board Temperature sensors T1, T2</p>
		5) Remove the PCB from the fixing pins	
3	Remove the fan motor and fan wheel	1) Remove the stickers stick to the volute shell	 <p>Stickers</p>

2) Remove the below volute shell

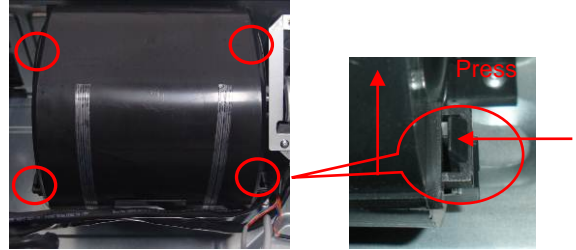

Press the clips to take off the volute shell



3) Disassemble the fan motor fixing clamps to remove the fan motor assembly and fan wheel assembly

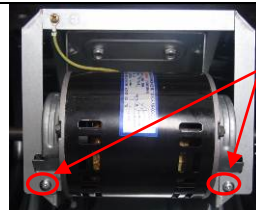

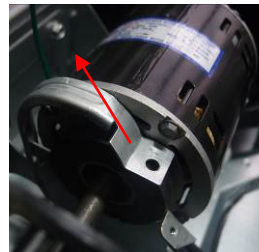

The fan motor assembly and fan wheel assembly can be removed after took off the 2screws used to fix the fan motor fixing clamps.



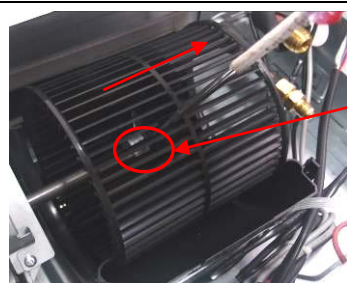

4) Release the screws locking the fan wheel on the shaft, you can remove the fan wheels.

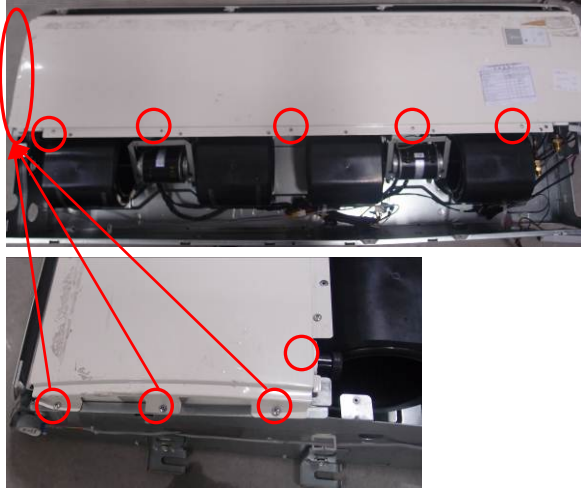

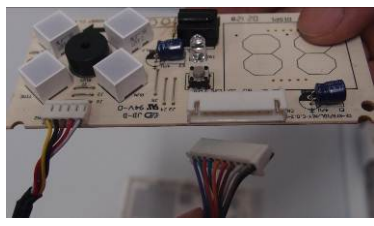
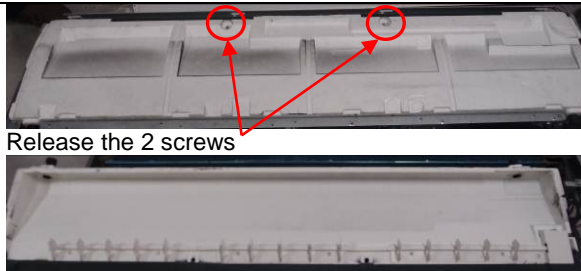
Take off the screw to remove the fan wheel

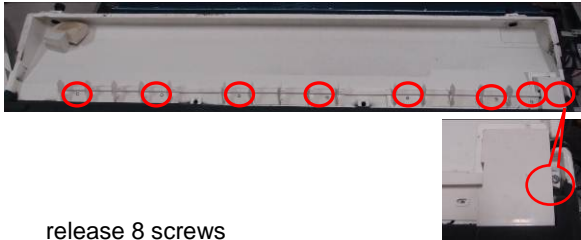
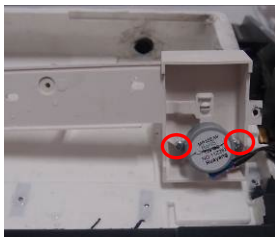
4	Remove the display PCB	1) Release the 2 screws (both sides) and push the panel upwards to remove it	 <p>Release the screw</p> <p>Push it upwards</p>
		2) Release 11 screws (5 at the front and 6 at both sides).	
		3) Remove the front panel. The display board is on the back.	
		4) Release 2 screws fixing the display PCB	
		5) Unplug the wires	
5**	Remove the vertical swing motor	1) Remove the drain pan assembly	 <p>Release the 2 screws</p>

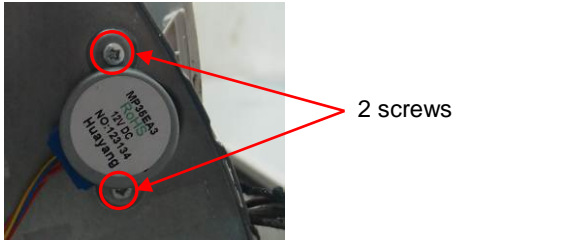
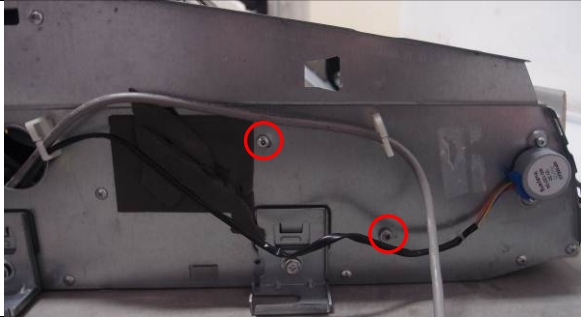
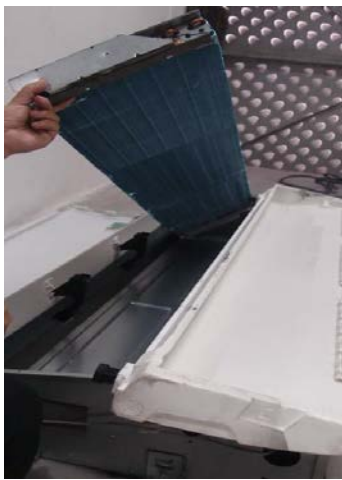
		2) Remove the air outlet grille assembly by screwing of 8 screws	 <p>release 8 screws</p>
		3) Release 2 screws fixing the swing motor to remove it	
6	Remove 2 horizontal swing motors (on both sides off the unit)	1) Remove the motor protective cover	
		2) Screw off the 2 fixing screws to remove swing motor	 <p>2 screws</p>
7	Remove the evaporator assembly	1) Remove the 4 screws (2 on left side and 2 on right side) fixing the evaporator on both sides of the unit.	
		2) Remove the evaporator	

PART - 1

GENERAL INFORMATION

1.4 OUTDOOR UNIT

DIMENSIONS

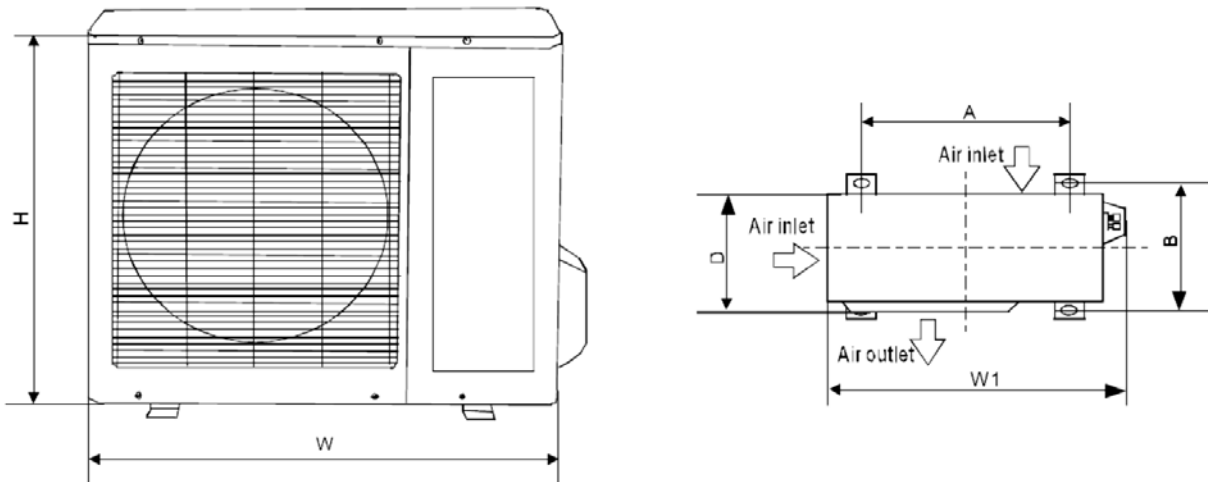

Model	W	D	H	W1	A	B
38QUS012/18DS*	810	310	558	874	549	325
38QUS024DS*	845	320	700	908	560	335

INSTALLTION SPACE

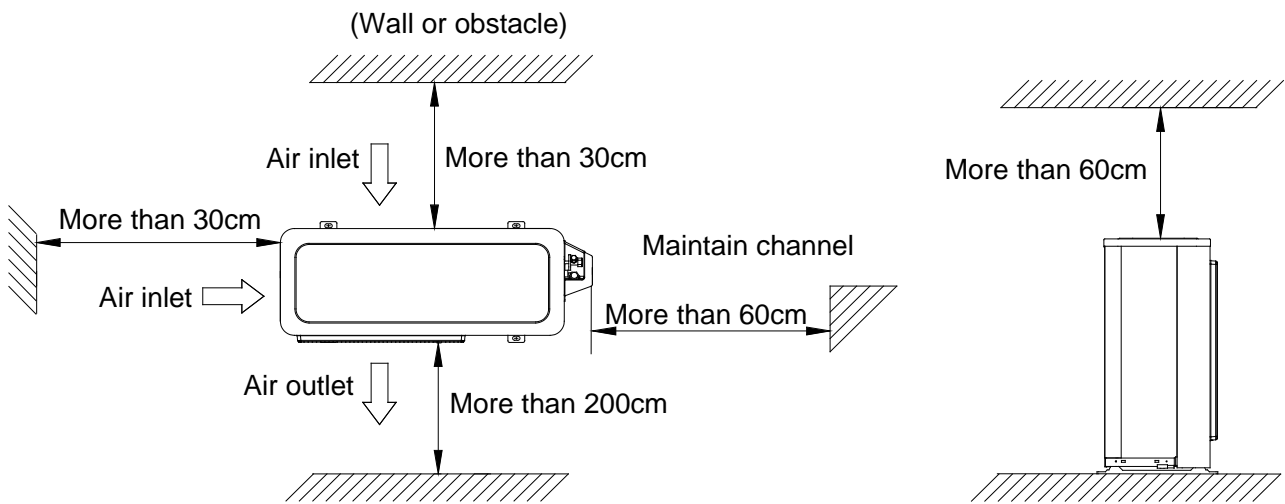



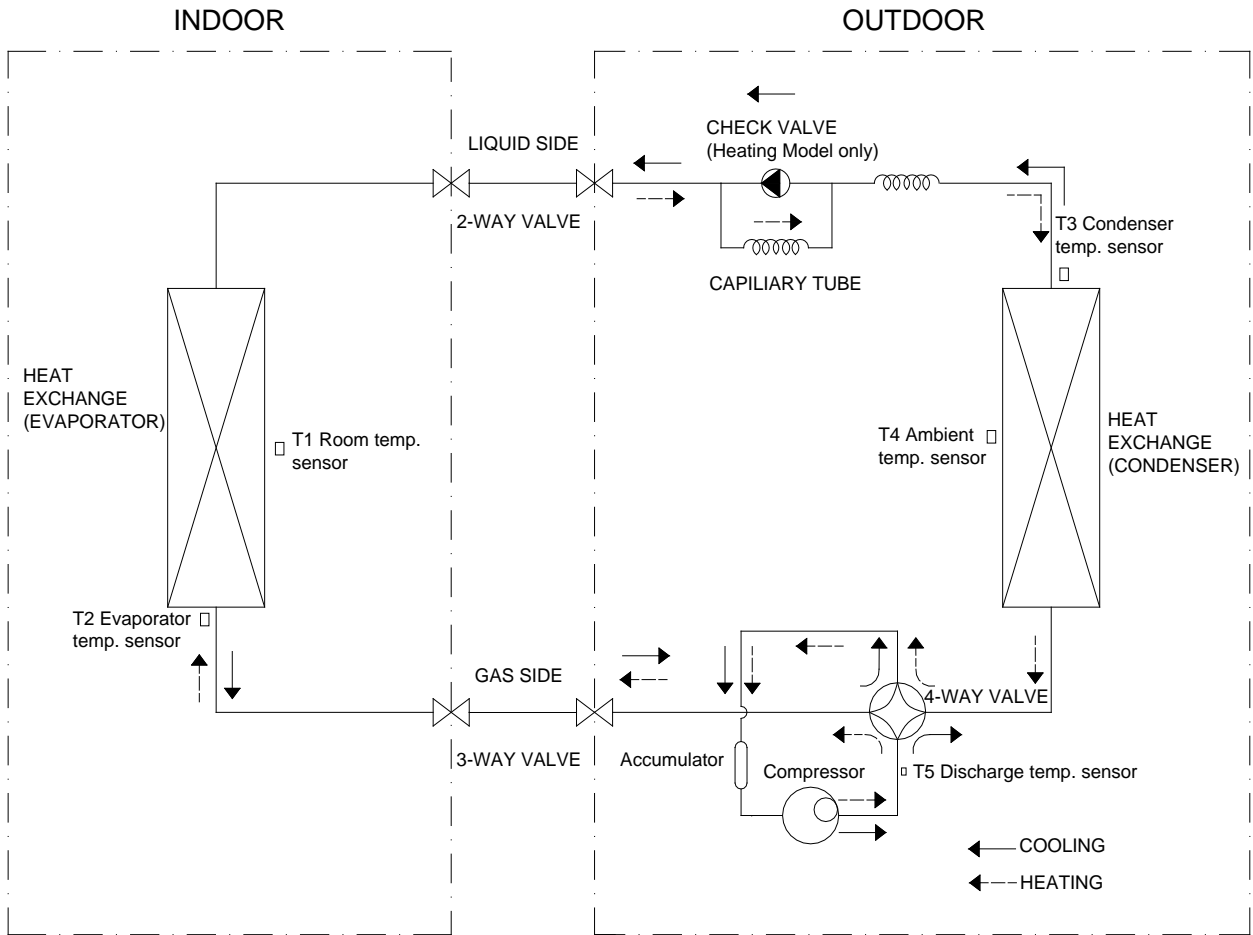

REFRIGERANT CYCLE DIAGRAM

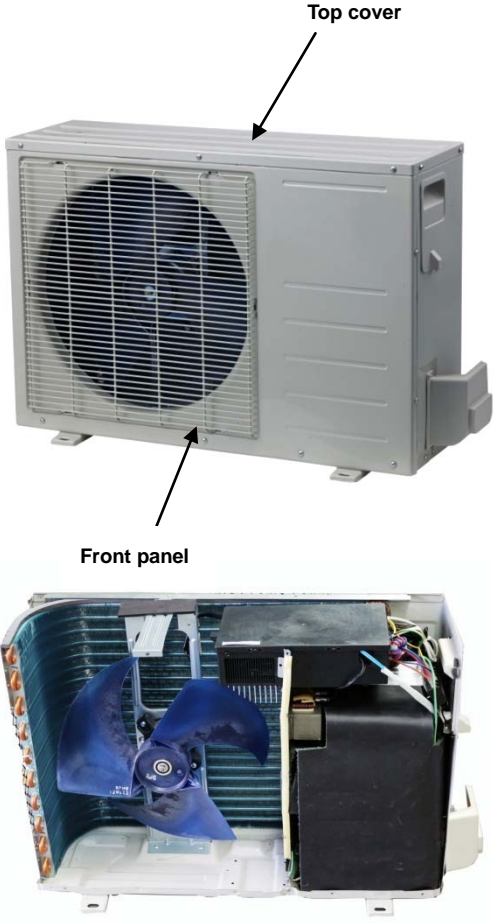
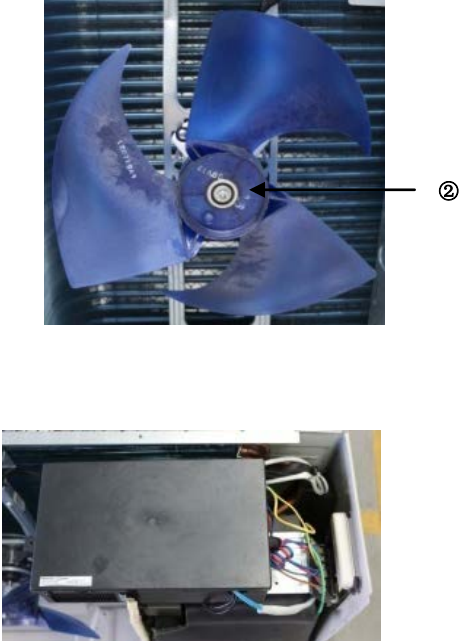

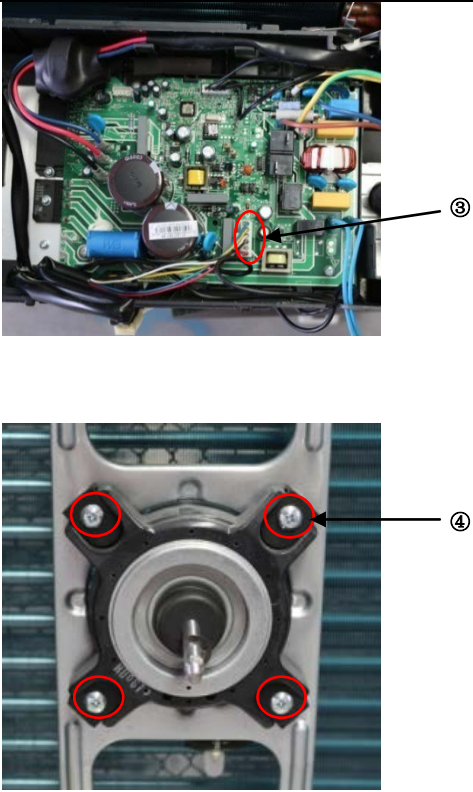
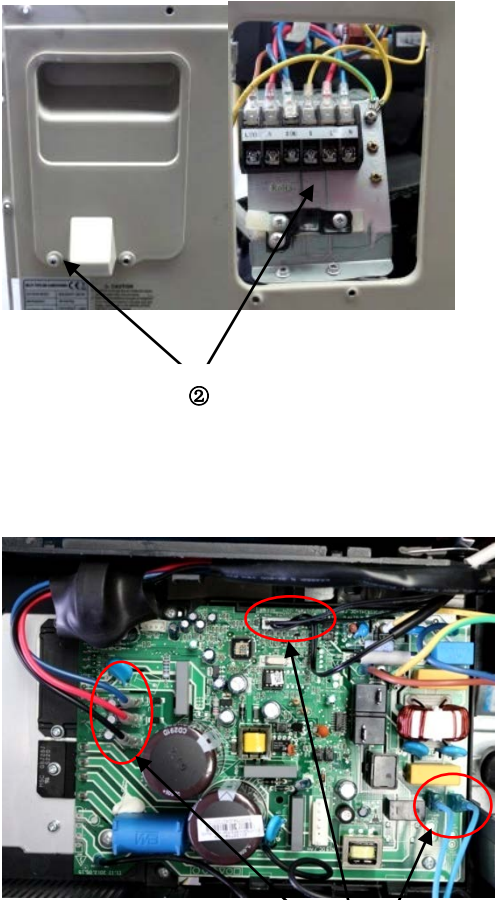
DISASSEMBLY INSTRUCTION

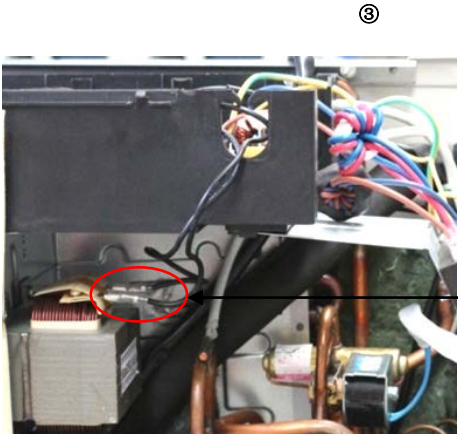
No.	Part name	Procedures	Remarks
1	Panel plate	<p>How to remove the panel plate.</p> <p>1) Stop operation of the air conditioner and turn "OFF" the power breaker.</p> <p>2) Remove the top cover. (7 screws)</p> <p>3) Remove the front panel. (8 screws)</p>	
2	Fan ass'y	<p>How to remove the fan ass'y.</p> <p>1) Remove the panel plate from procedure 1.</p> <p>2) Remove the hex nut fixing the fan and then the fan can be removed.</p> <p>3) Open the electronic box cover fixing with clips and</p>	

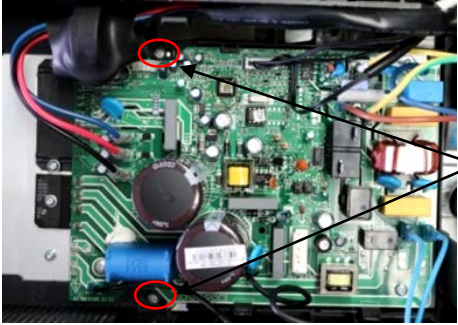
		<p>release the fan motor connector.</p> <p>4) Remove the four fixing screws.</p> <p>Remove the fan motor.</p>	
3	Electrical parts	<p>How to remove the electrical parts.</p> <p>1) Perform work of item 1,2.</p> <p>2) Remove the two fixing screws of wiring cover and the two fixing screws of wiring board.</p> <p>3) Remove the wires connected with the compressor, the 4-way valve and the temp.sensors(T3,T4,T5).</p>	

		<p>4) Remove the wires connected with the reactor.</p> <p>5) Remove the grounding wire.</p> <p>6) Remove the two screws fixing the electronic control box.</p> <p>7) Then remove the electrical parts.</p>	  
4	Compressor	<p>How to remove the compressor.</p> <p>1) Perform work of item 1,2,3</p> <p>2) Remove the discharge pipe and suction pipe with a burner.</p> <p>3) Remove the hex nuts and washers fixing the</p>	

		<p>compressor on bottom plate.</p> <p>4) Lift the compressor from the base pan assembly.</p>	
--	--	--	--

PART - 2
ELECTRICAL DIAGRAM

WIRING DIAGRAM - 42QSM012/18/24DS*

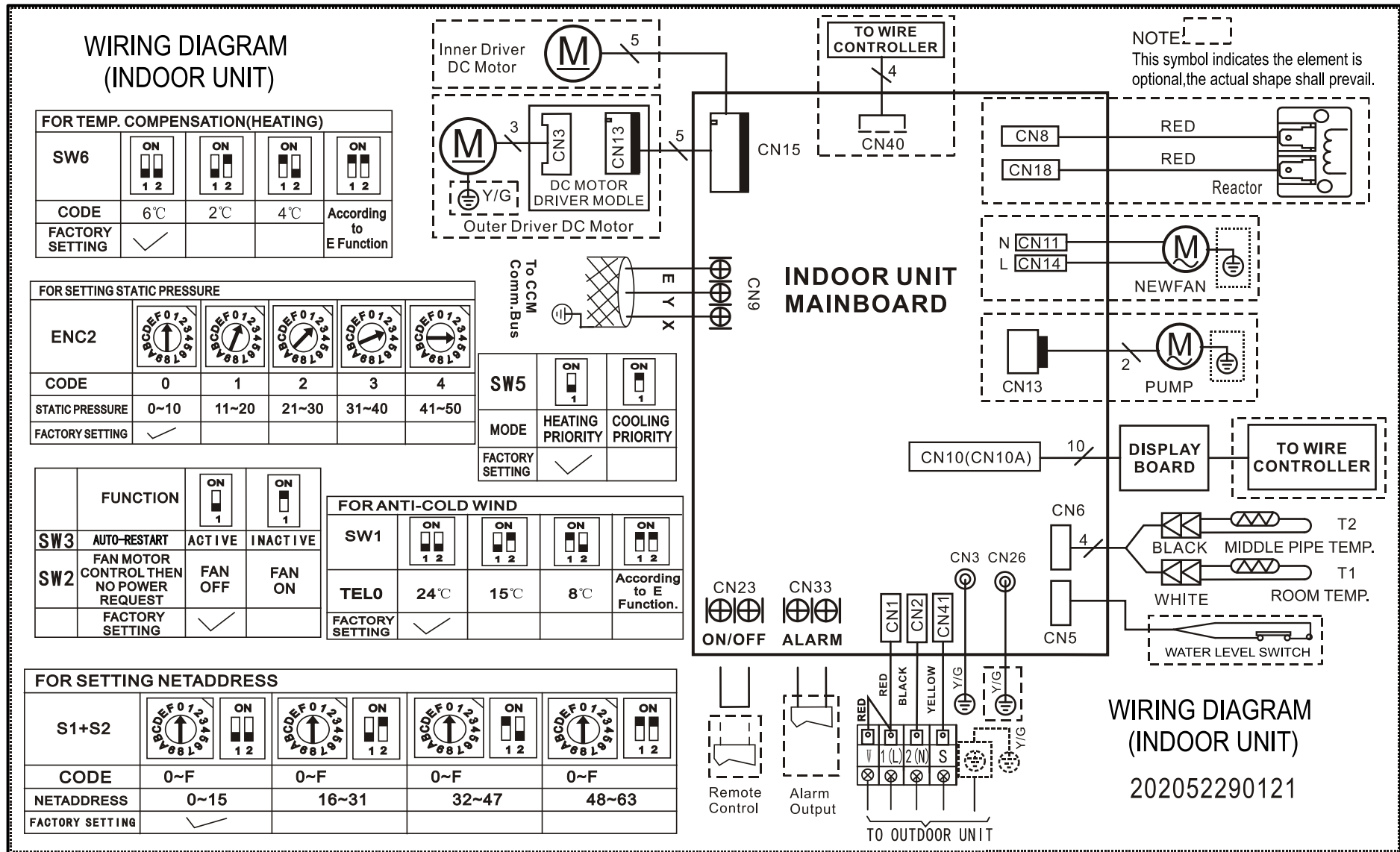

WIRING DIAGRAM - 42QTD012/18DS*

202052390095

FUNCTION OF SWITCH

SWITCH	FOR CCM UNIT ADDRESS	
S2 + S1		
ADDRESS	0~15	16~31
Factory Setting	<input checked="" type="checkbox"/>	
S2 + S1		
ADDRESS	32~47	48~63
Factory Setting		

Anti-cold air	
SW1	FAN MOTOR STOP-TEM
	24 Factory setting <input checked="" type="checkbox"/>
	15
	8
	According to the EEPROM setting

SW3	SWITCH	FOR AUTO-RESTART SETTING	
ON:			
STATE			
MODE	REMEMBER	NO_REMEMBER	
Factory Setting	<input checked="" type="checkbox"/>		

SW2	SWITCH	FOR FAN MOTOR CONTROL THEN NO POWER REQUEST.	
ON:			
STATE			
MODE	FAN OFF	FAN ON	
Factory Setting	<input checked="" type="checkbox"/>		

SW6	SWITCH	FOR TEMP. COMPENSATION			
ON:					
STATE					
VALUE	6	4	2	E function	
Factory Setting	<input checked="" type="checkbox"/>				

SW5	SWITCH	FOR MODE-PRIOR SETTING			
ON:					
STATE					
MODE	HEAT	HEAT	COOL	COOL	
Factory Setting	<input checked="" type="checkbox"/>				

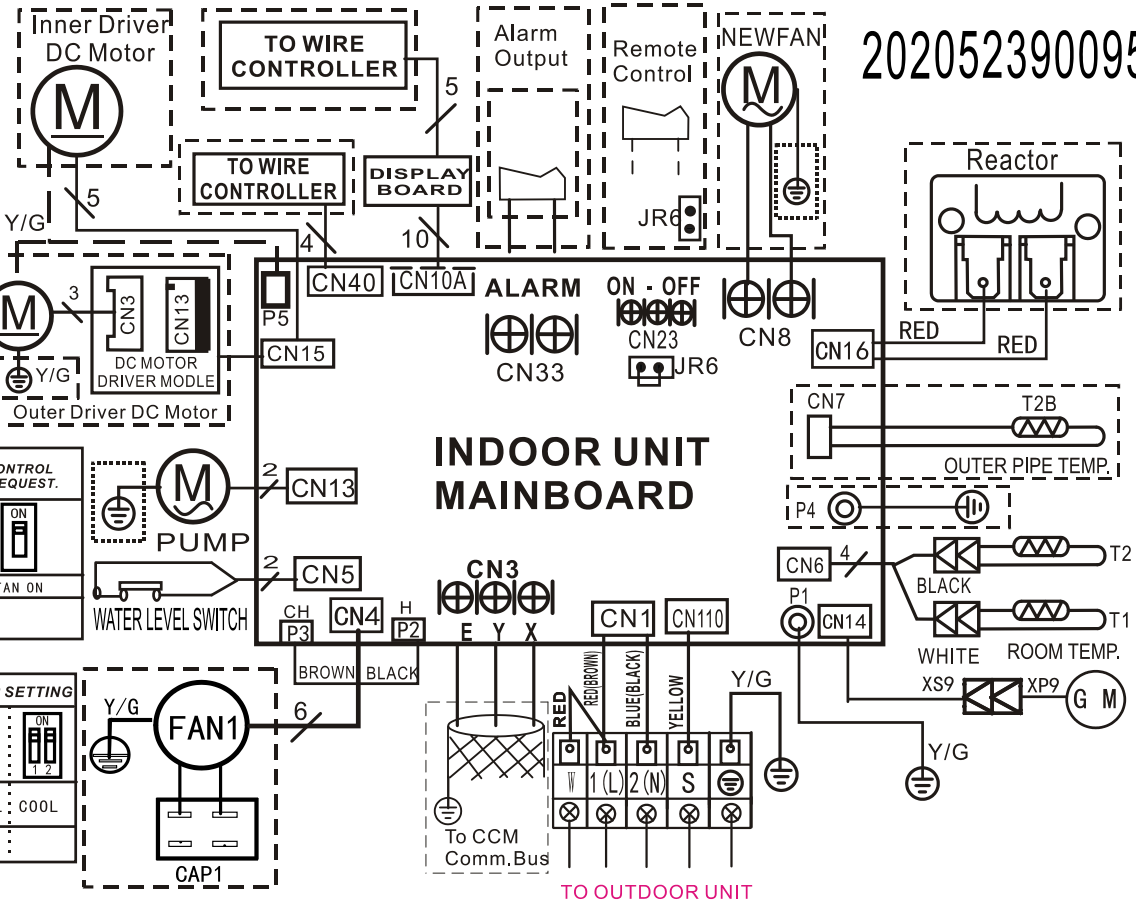

WIRING DIAGRAM - 42QTD024DS*

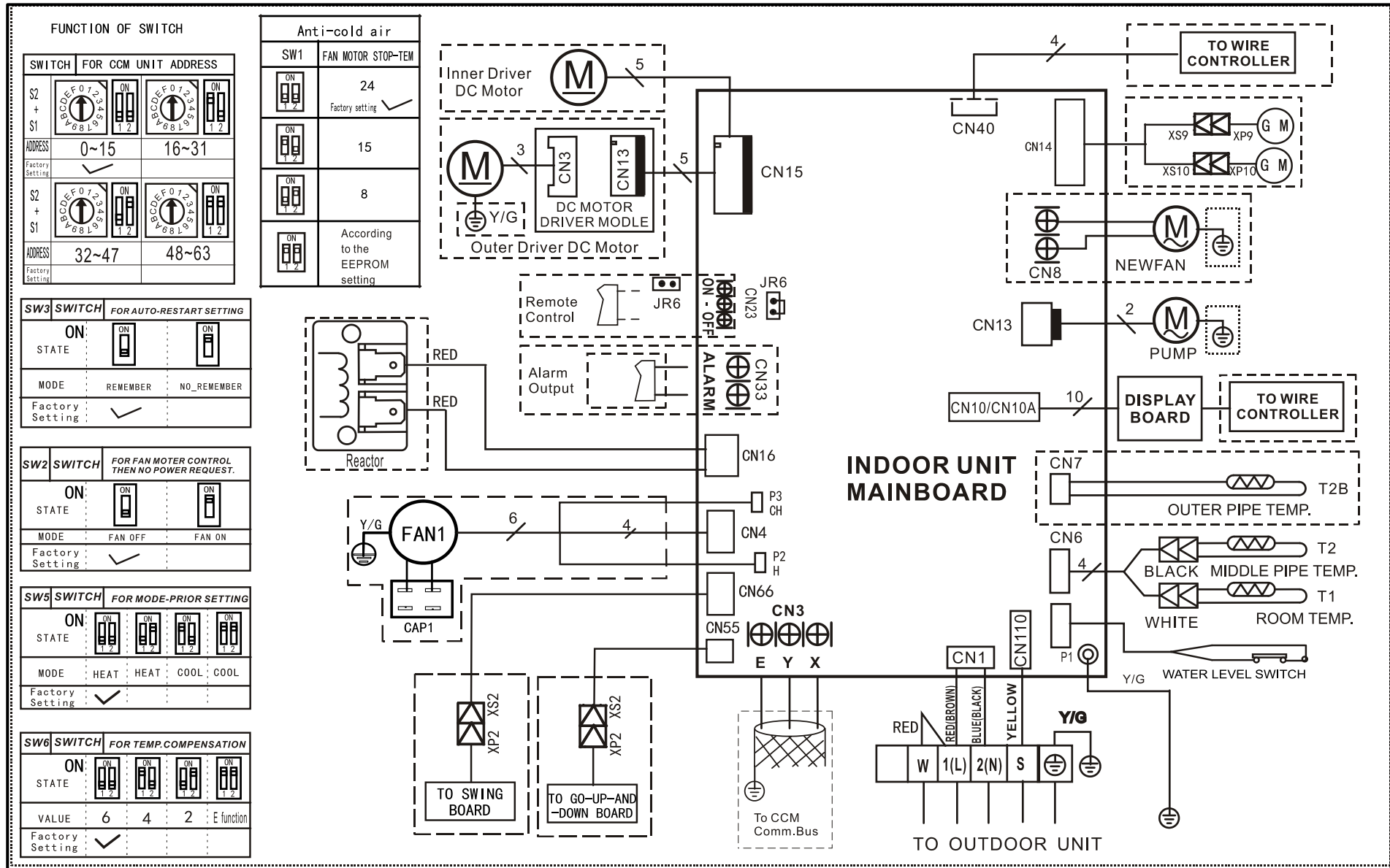

WIRING DIAGRAM - 42QZL018/24DS*

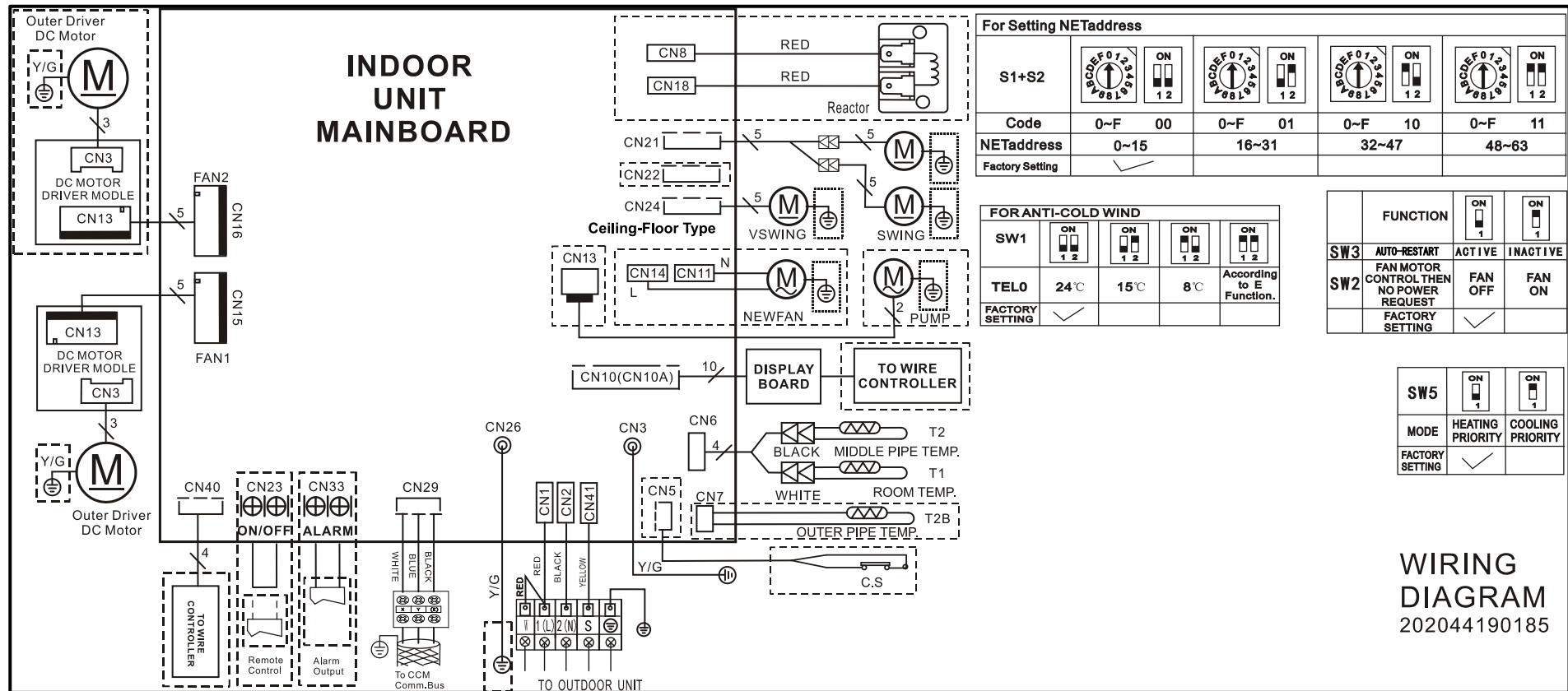

WIRING
DIAGRAM
202044190185

WIRING DIAGRAM - 38QUS012DS*

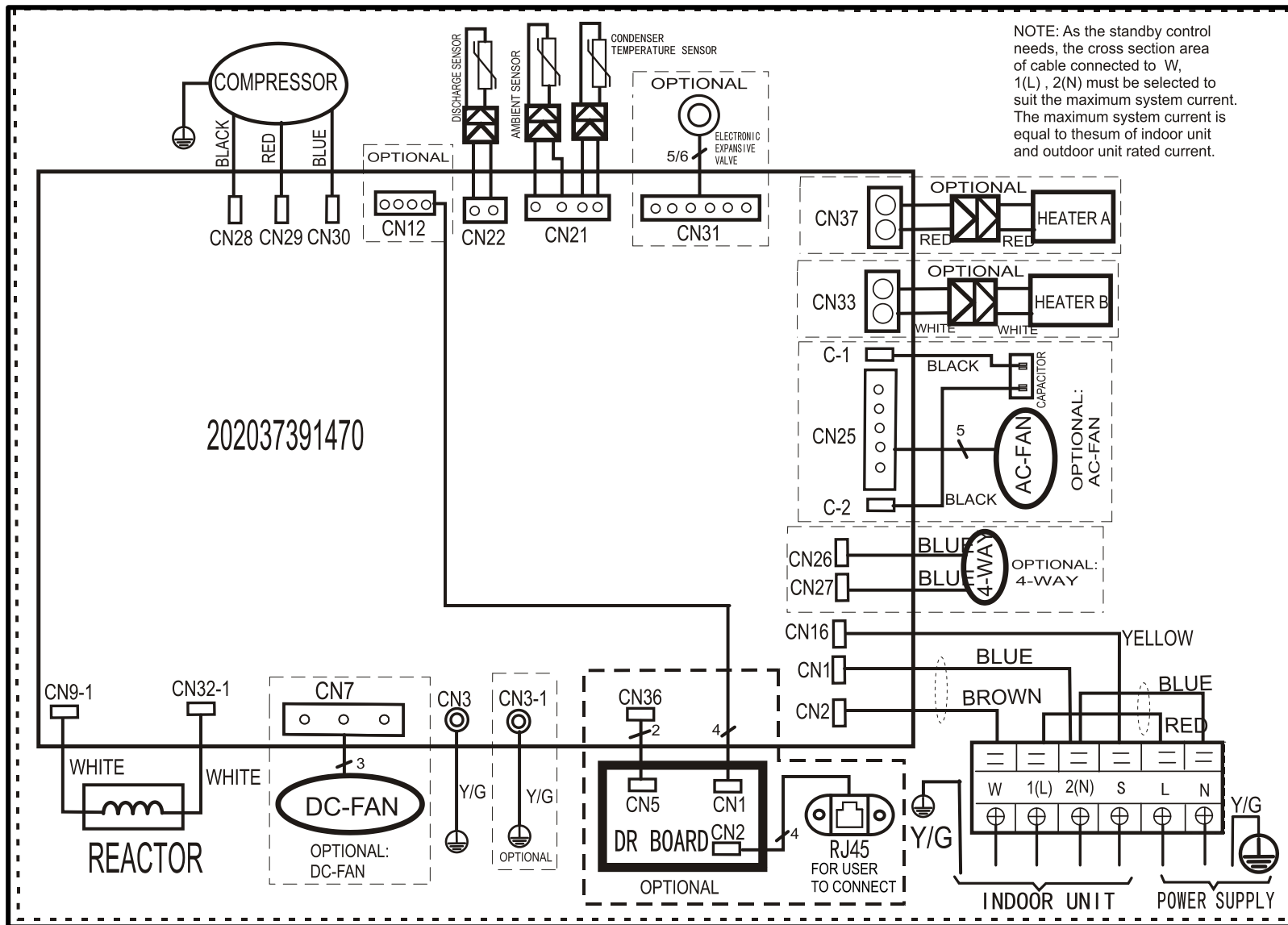

WIRING DIAGRAM – 38QUS018DS*

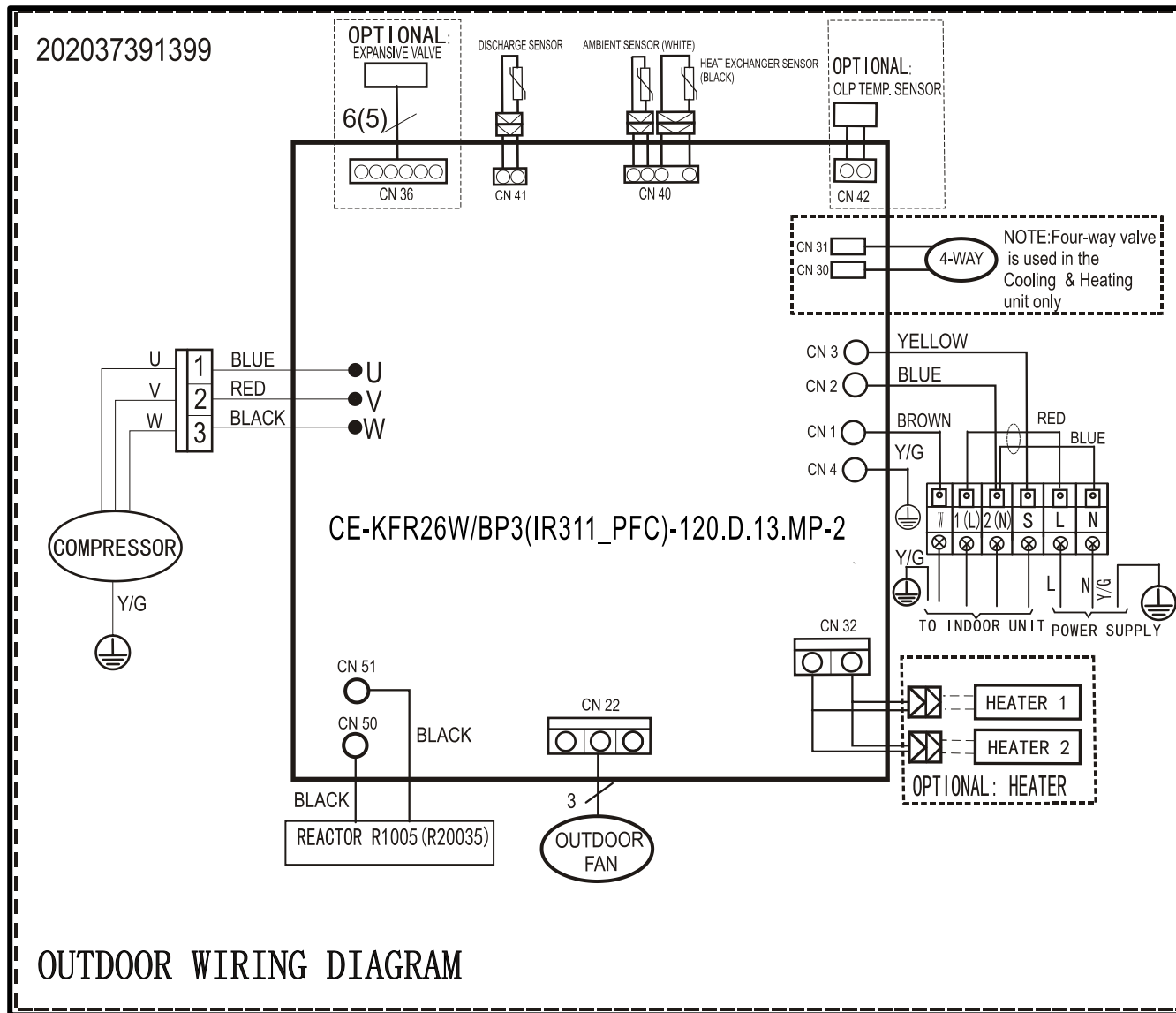

WIRING DIAGRAM - 38QUS024DS*

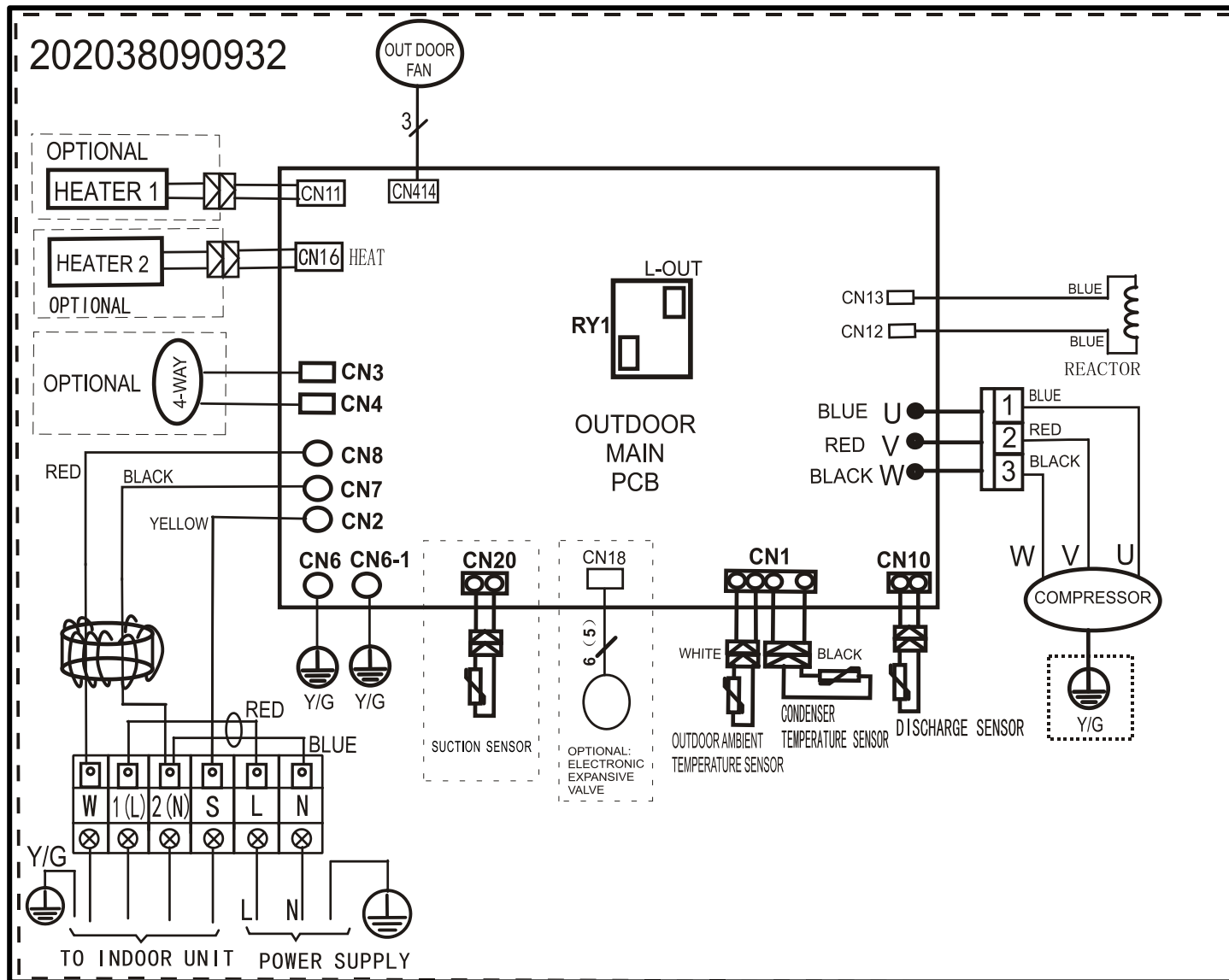

PART – 3

TROUBLE SHOOTING

SAFETY CAUTION

Electricity power is still kept in capacitors even the power supply is shut off. Do not forget to discharge the electricity power in capacitor.

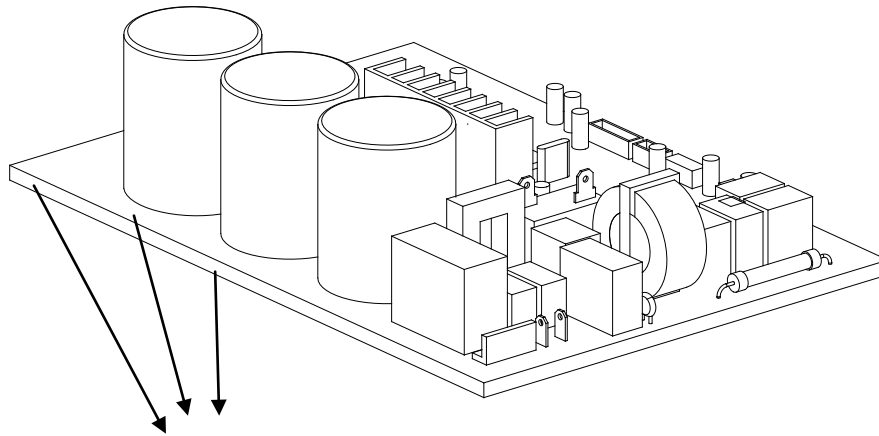

Electrolytic Capacitors
(HIGH VOLTAGE! CAUTION!)

Connect discharge resistance (approx.100Ω 40W) or soldering iron (plug) between +, - terminals of the electrolytic capacitor on the contrary side of the outdoor PCB.

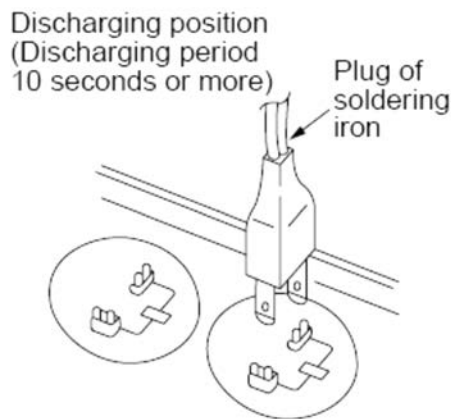

Note: The picture above is only for reference. The plug of your side may be different.

ERROR CODE

Abbreviation

T1: Indoor ambient temperature

T2: Coil temperature of indoor heat exchanger middle.

T3: Coil temperature of outdoor heat exchanger

T4: Outdoor ambient temperature

T5: Compressor discharge temperature

Indoor Unit

Operation lamp	Timer lamp	Digital Display	Led Status	Remark
☆ 1 time	X	E0	Indoor unit EEPROM parameter error	
☆ 2 times	X	E1	Indoor / outdoor units communication error	
☆ 3 times	X	E2	Zero crossing signal detection error	Only available for AC motor of high-wall
☆ 4 times	X	E3	Indoor fan speed has been out of control	
☆ 5 times	X	E4	Open circuit or short circuit of indoor room temperature T1 sensor	
☆ 6 times	X	E5	Open circuit or short circuit of evaporator coil temperature T2 sensor	
☆ 7 times	X	EC	Refrigerant Leakage Detection	Only available for single split
☆ 8 times	X	EE	Water-level alarm malfunction	Only available for unit with drain pump
☆ 1 time	O	F0	Operation current protection	
☆ 2 times	O	F1	Open circuit or short circuit of outdoor ambient T4 temperature sensor	
☆ 3 times	O	F2	Open circuit or short circuit of condenser coil temperature T3 sensor	
☆ 4 times	O	F3	Open circuit or short circuit of compressor discharge T5 temperature sensor	
☆ 5 times	O	F4	Outdoor unit EEPROM parameter error	
☆ 6 times	O	F5	Outdoor fan speed has been out of control	
☆ 7 times	O	F6	Open or short circuit of T2B temperature sensor	Only available for multi-split outdoor unit
☆ 1 times	☆	P0	IPM malfunction or IGBT over-strong current protection	
☆ 2 times	☆	P1	Over voltage or over low voltage protection	
☆ 3 times	☆	P2	High temperature protection of compressor top	Only for 38QUS022/24DS
☆ 5 times	☆	P4	Inverter compressor drive error	
☆ 6 times	☆	P5	Mode conflict	Only available for multi-split

O (light)

X (off)

☆ (flash)

Trouble Shooting of Indoor Error Code

1 EEPROM parameter error diagnosis and solution (E0/F4)

Error Code	E0/F4
Malfunction decision conditions	Indoor or outdoor PCB main chip does not receive feedback from EEPROM chip.
Supposed causes	<ul style="list-style-type: none">● Installation mistake● PCB faulty

Trouble shooting:

Power off, then restart the unit 2 minutes later.

Yes

Replace the indoor/outdoor main PCB.

EEPROM: An electrically erasable programmable read-only memory whose contents can be erased and reprogrammed using a pulsed voltage.

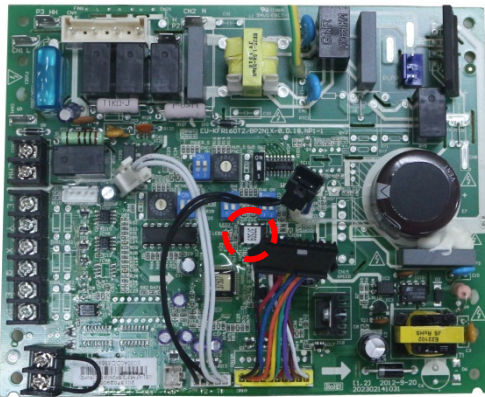

Indoor PCB

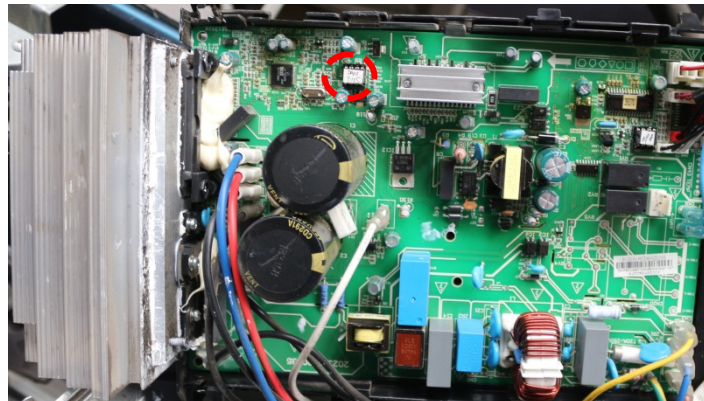

Outdoor PCB

Note: The two photos above are only for reference, it may be not same totally with the ones on your side.

2 Indoor unit and outdoor unit communication protection error diagnosis and solution (E1)

Error Code	E1
Malfunction decision conditions	Indoor unit does not receive the feedback from outdoor unit during 110 seconds and this condition happens four times continuously.
Supposed causes	<ul style="list-style-type: none"> ● Wiring mistake ● Indoor or outdoor PCB faulty

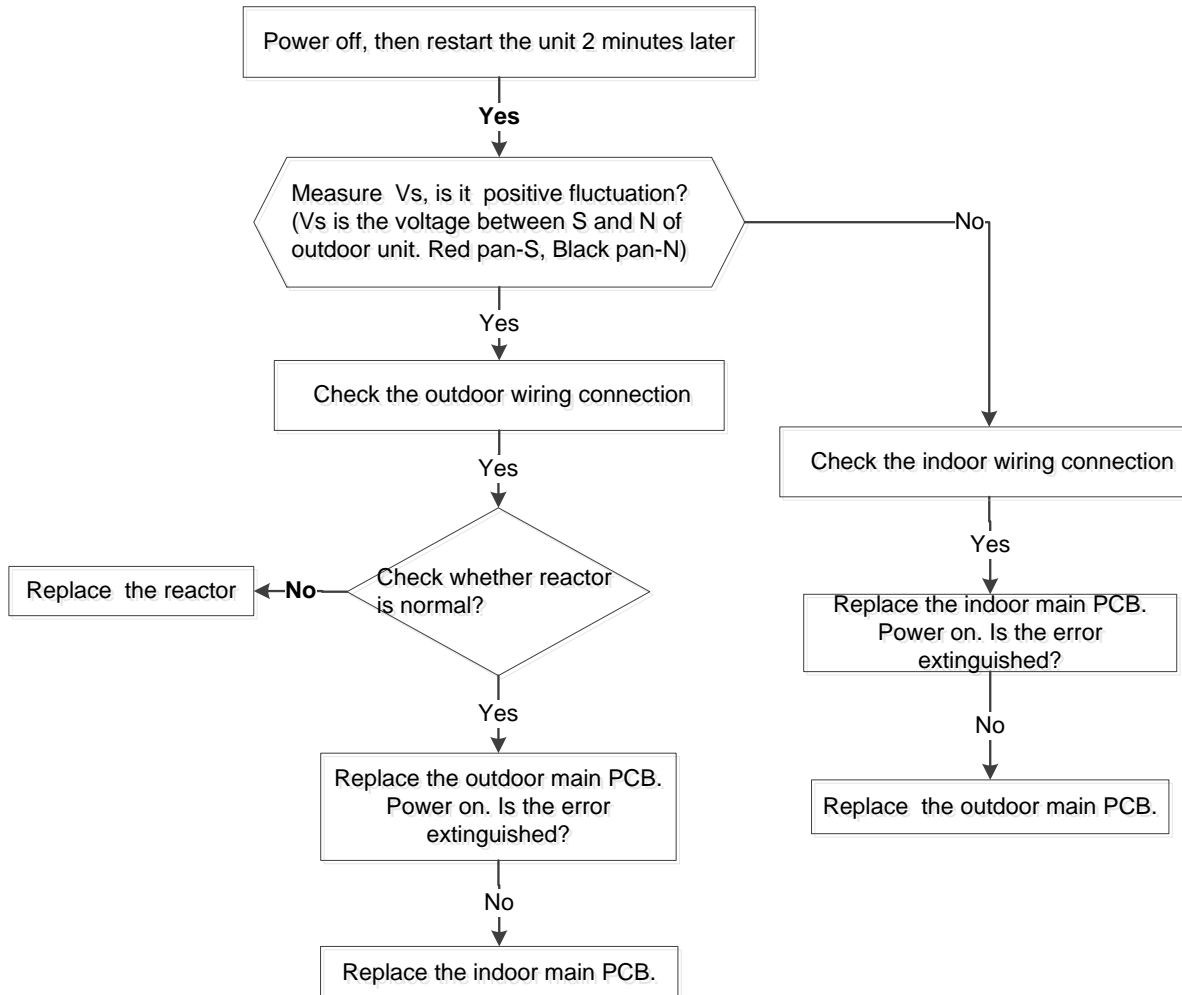

3 Zero crossing detection error diagnosis and solution (E2)

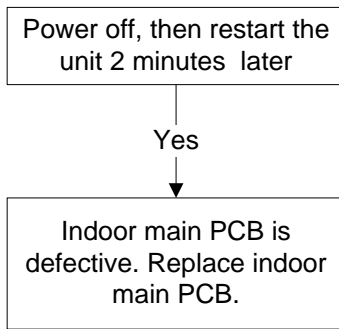

Only available for AC motor of high-wall.

4 Fan speed has been out of control diagnosis and solution (E3/F5)

Error Code	E3/F5
Malfunction decision conditions	When indoor fan speed keeps too low (300RPM) for certain time, the unit will stop and the LED will display the failure.
Supposed causes	<ul style="list-style-type: none"> ● Wiring mistake ● Fan ass'y faulty ● Fan motor faulty ● PCB faulty

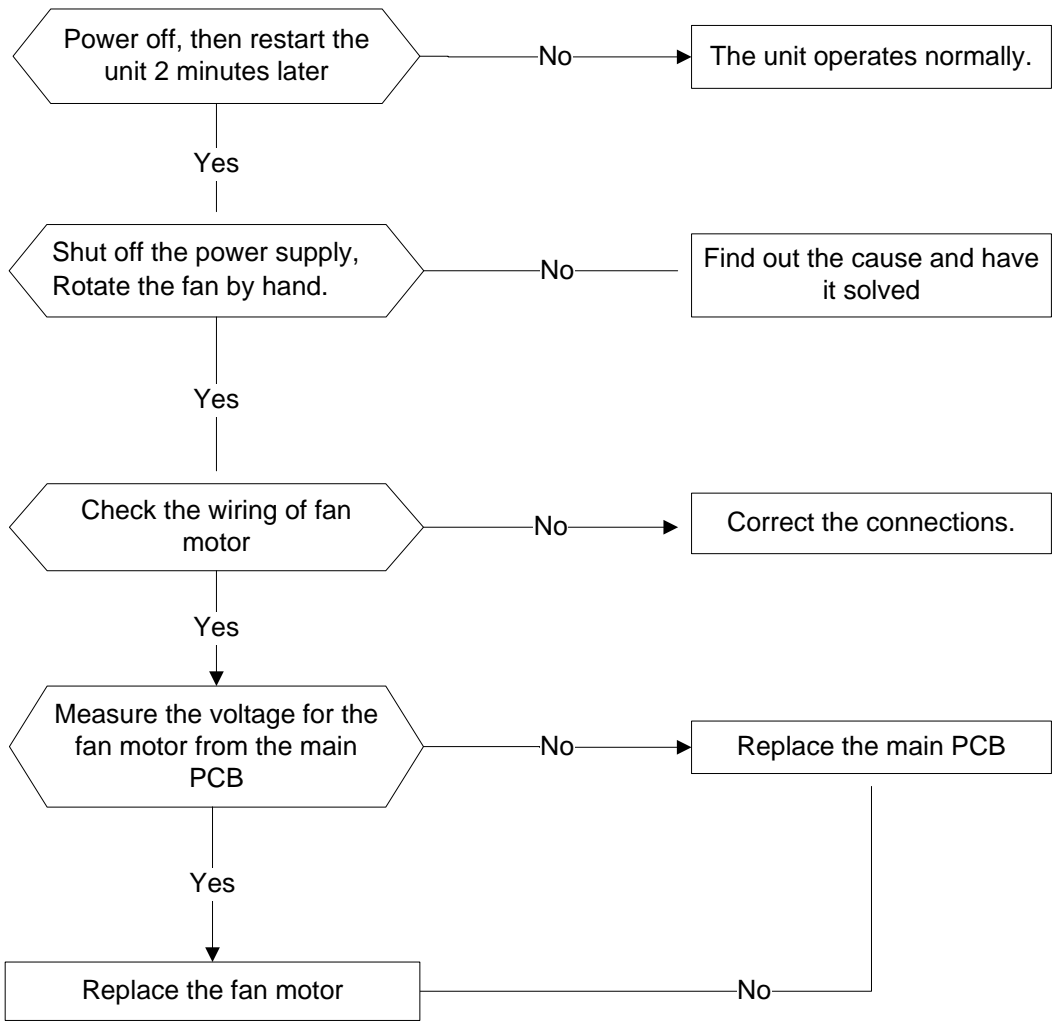

5 Open circuit or short circuit of temperature sensor diagnosis and solution (E4/E5/F1/F2/F3)

Error Code	E4/E5/F1/F2/F3
Malfunction decision conditions	If the sampling voltage is lower than 0.06V or higher than 4.94V, the LED will display the failure.
Supposed causes	<ul style="list-style-type: none">● Wiring mistake● Sensor faulty

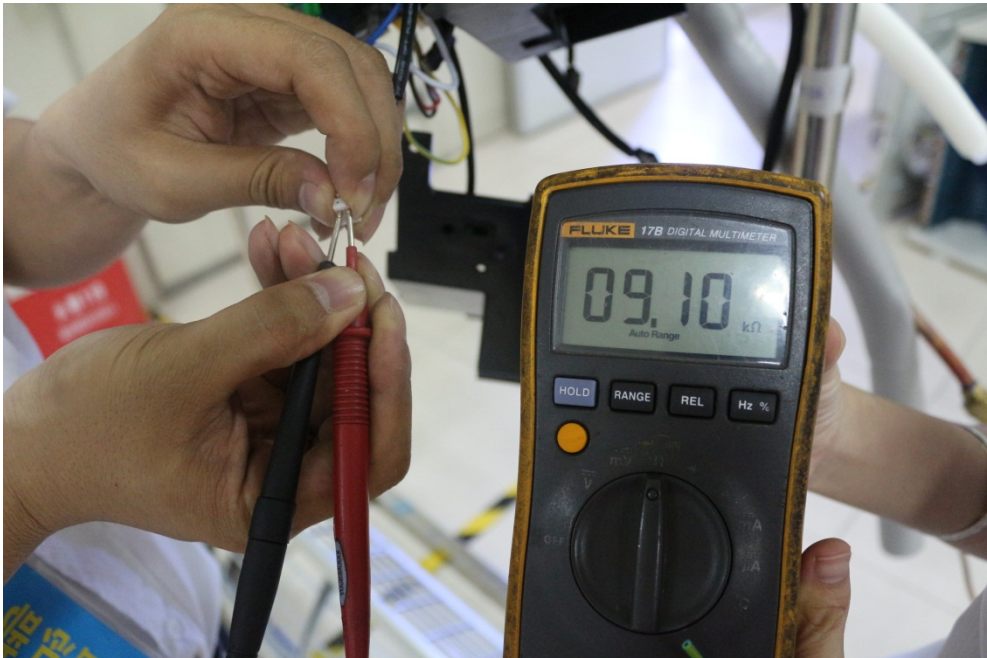
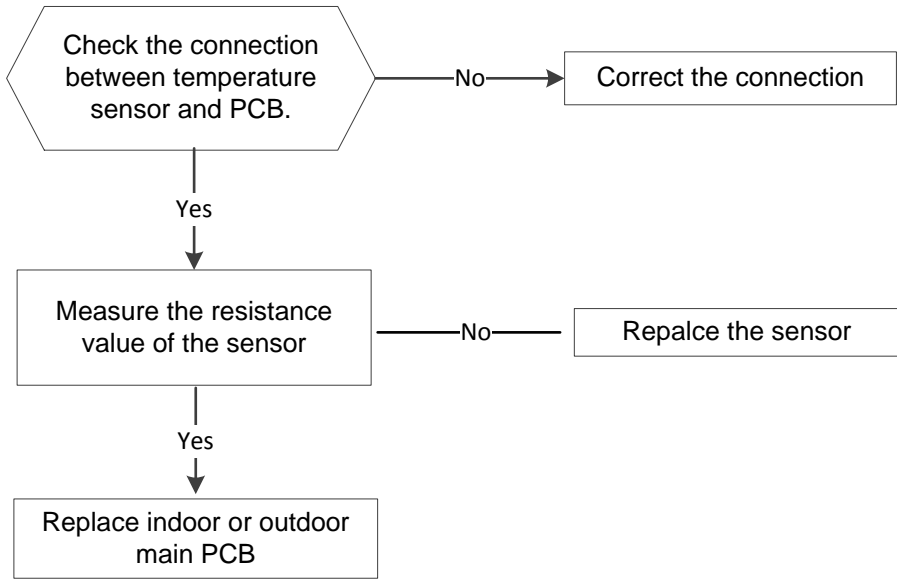

6 Refrigerant Leakage Detection diagnosis and solution (EC)

Error Code	EC
Malfunction decision conditions	<p>Define the evaporator coil temp.T2 of the compressor just starts running as Tcool.</p> <p>In the beginning 5 minutes after the compressor starts up, if $T2 < T_{cool} - 2^{\circ}\text{C}$ does not keep continuous 4 seconds and this situation happens 3 times, the display area will show “EC” and AC will turn off.</p>
Supposed causes	<ul style="list-style-type: none"> ● T2 sensor faulty ● Indoor PCB faulty ● System problems, such as leakage or blocking.

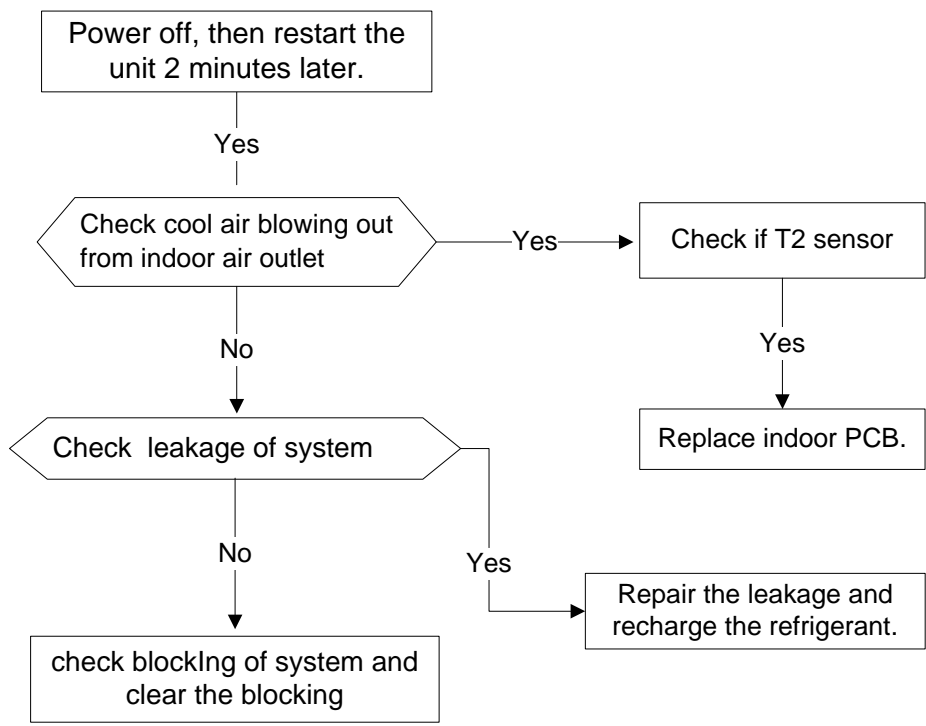

7 Water-level alarm malfunction diagnosis and solution

Error Code	EE
Malfunction decision conditions	If the sampling voltage is not 5V, the LED will display the failure.
Supposed causes	<ul style="list-style-type: none"> ● Wiring mistake ● Water-level switch faulty ● Water pump faulty ● Indoor PCB faulty

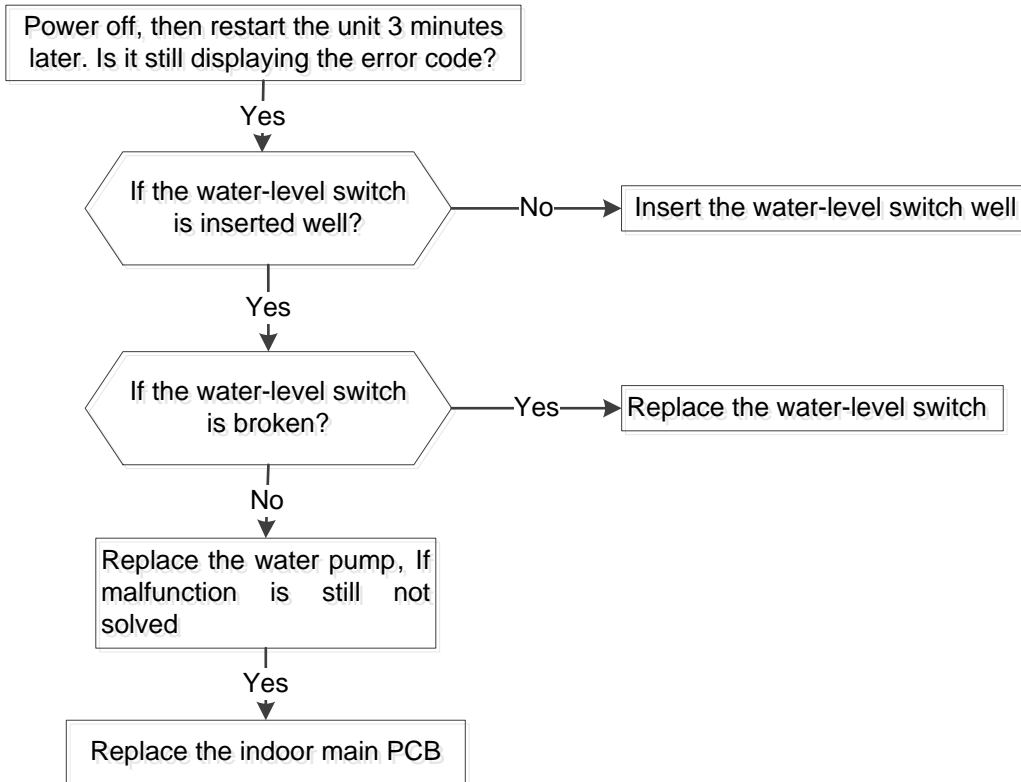

8 Operation current protection (F0)

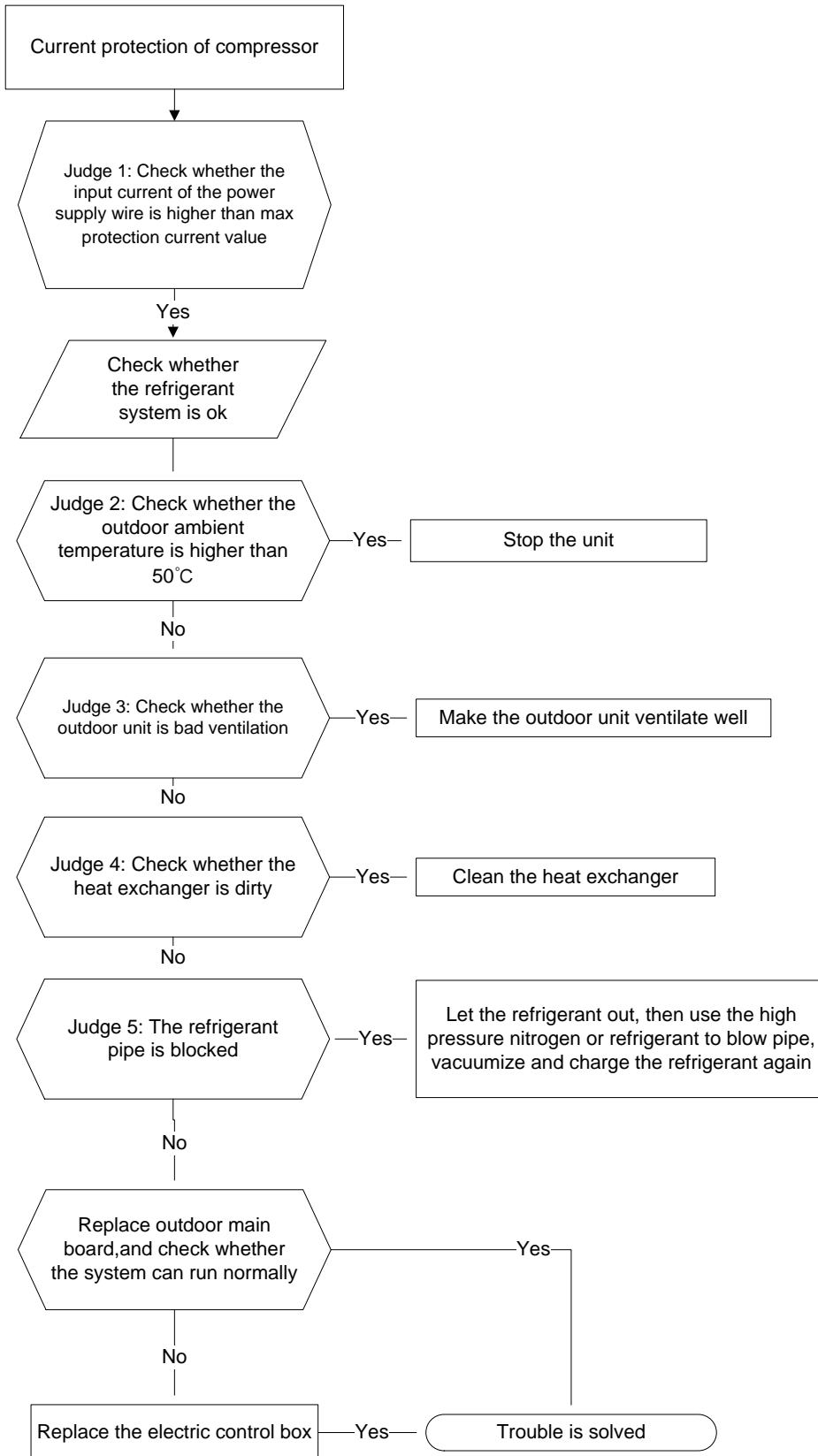

9 IPM malfunction or IGBT over-strong current protection diagnosis and solution (P0)

Error Code	P0
Malfunction decision conditions	When the voltage signal that IPM send to compressor drive chip is abnormal, the display LED will show “P0” and AC will turn off.
Supposed causes	Wiring mistake; IPM malfunction; Outdoor fan ass’y faulty Compressor malfunction; Outdoor PCB faulty

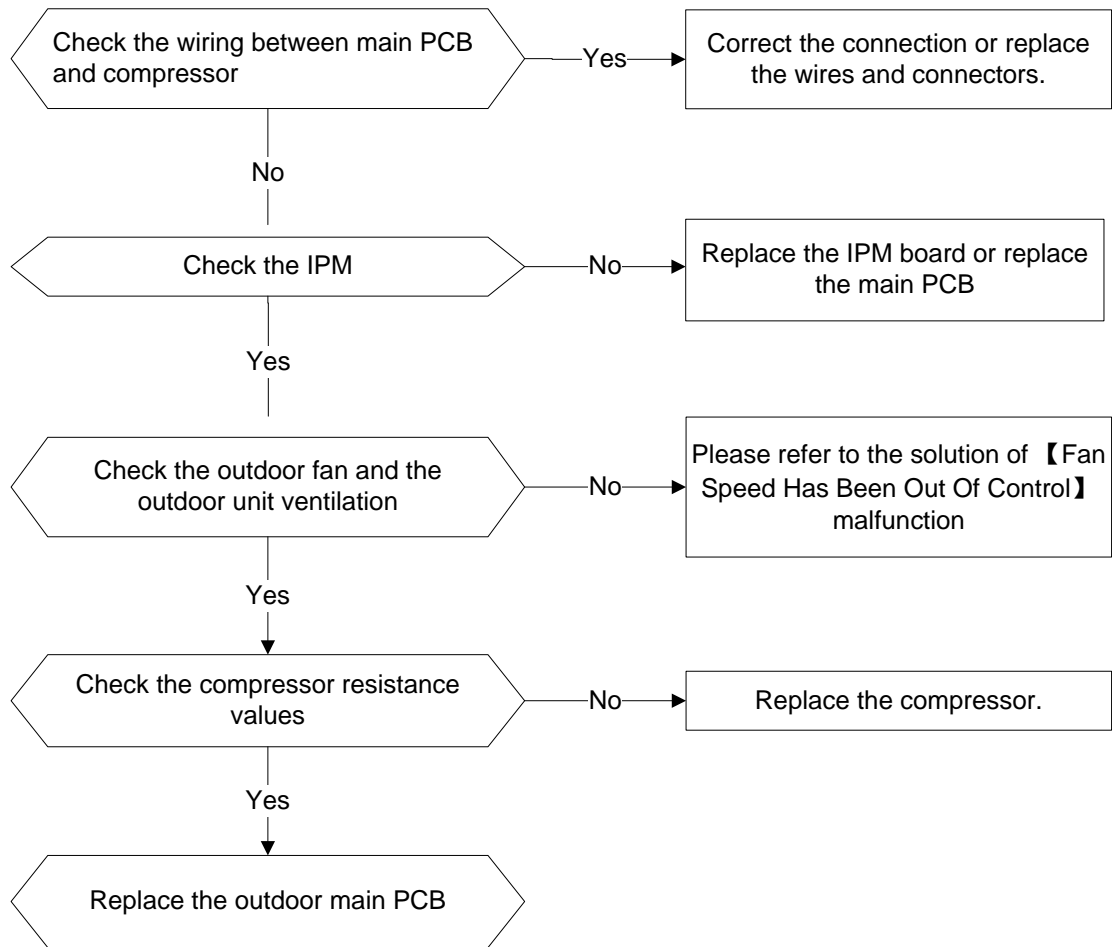

10 Over voltage or too low voltage protection diagnosis and solution (P1)

Error Code	P1
Malfunction decision conditions	An abnormal voltage rise or drop is detected by checking the specified voltage detection circuit.
Supposed causes	<ul style="list-style-type: none"> ● Power supply problems. ● System leakage or block ● PCB faulty

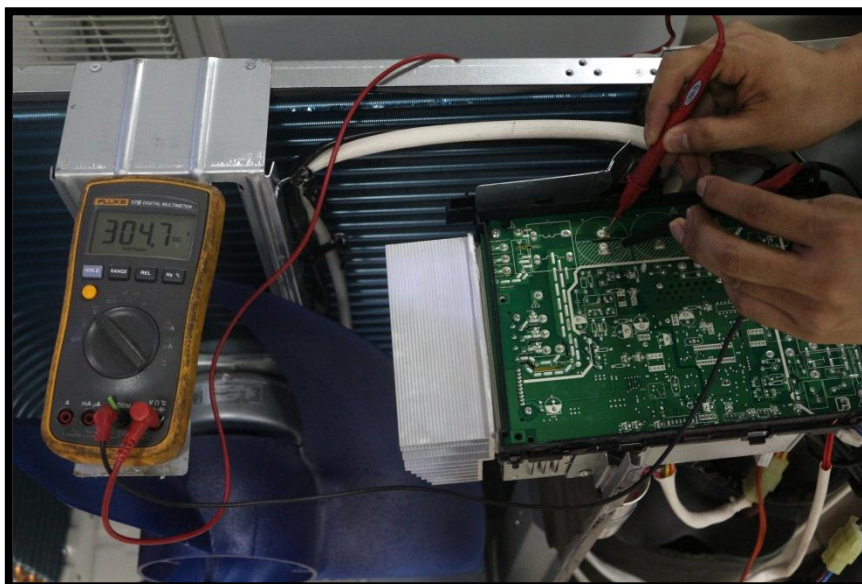
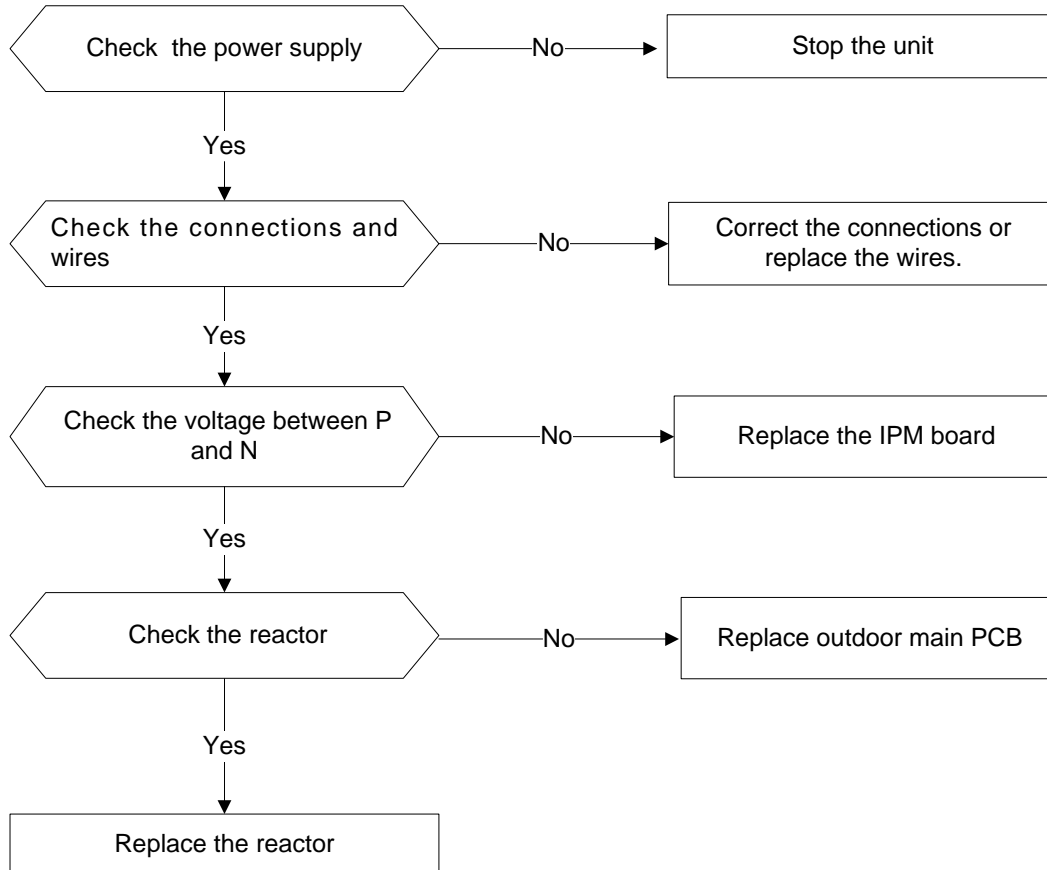

Remark:

Measure the DC voltage between P and N port. The normal value should be around 310V.

11 High temperature protection of compressor top diagnosis and solution (P2)

Error Code	P2
Malfunction decision conditions	If the sampling voltage is not 5V, the LED will display the failure.
Supposed causes	<ul style="list-style-type: none"> ● Power supply problems. ● System leakage or block ● PCB faulty

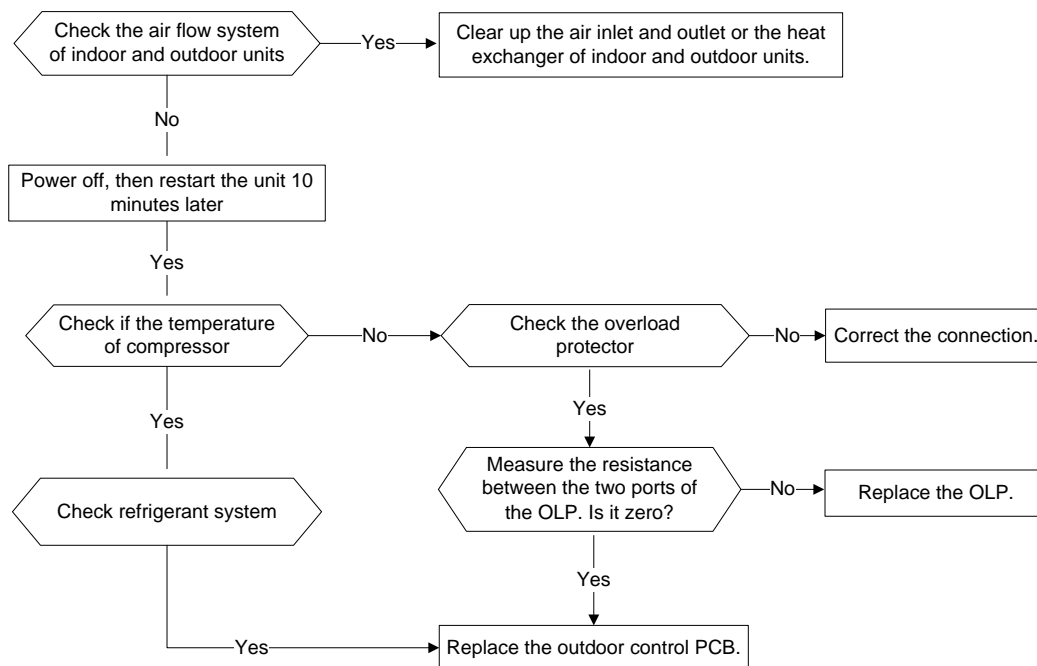

12 Inverter compressor drive error diagnosis and solution (P4)

Error Code	P4
Malfunction decision conditions	An abnormal inverter compressor drive is detected by a special detection circuit, including communication signal detection, voltage detection, compressor rotation speed signal detection and so on.
Supposed causes	Wiring mistake; IPM malfunction; Outdoor fan ass'y faulty Compressor malfunction; Outdoor PCB faulty

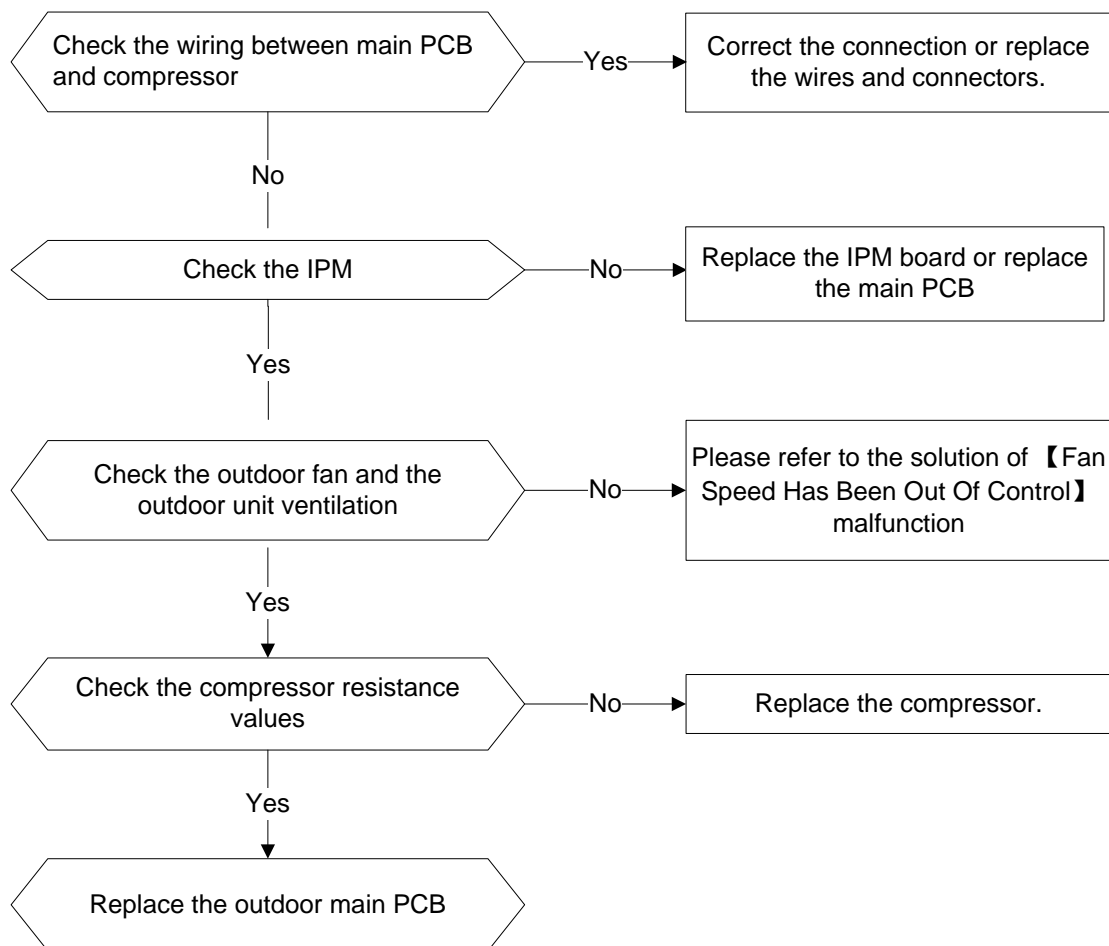

APPENDIX 1

Temperature Sensor Resistance Value Table, B=4100K

°C	K Ohm	°C	K Ohm	°C	K Ohm	°C	K Ohm
-20	115.266	20	12.6431	60	2.35774	100	0.62973
-19	108.146	21	12.0561	61	2.27249	101	0.61148
-18	101.517	22	11.5000	62	2.19073	102	0.59386
-17	96.3423	23	10.9731	63	2.11241	103	0.57683
-16	89.5865	24	10.4736	64	2.03732	104	0.56038
-15	84.2190	25	10.000	65	1.96532	105	0.54448
-14	79.3110	26	9.55074	66	1.89627	106	0.52912
-13	74.5360	27	9.12445	67	1.83003	107	0.51426
-12	70.1698	28	8.71983	68	1.76647	108	0.49989
-11	66.0898	29	8.33566	69	1.70547	109	0.48600
-10	62.2756	30	7.97078	70	1.64691	110	0.47256
-9	58.7079	31	7.62411	71	1.59068	111	0.45957
-8	56.3694	32	7.29464	72	1.53668	112	0.44699
-7	52.2438	33	6.98142	73	1.48481	113	0.43482
-6	49.3161	34	6.68355	74	1.43498	114	0.42304
-5	46.5725	35	6.40021	75	1.38703	115	0.41164
-4	44.0000	36	6.13059	76	1.34105	116	0.40060
-3	41.5878	37	5.87359	77	1.29078	117	0.38991
-2	39.8239	38	5.62961	78	1.25423	118	0.37956
-1	37.1988	39	5.39689	79	1.21330	119	0.36954
0	35.2024	40	5.17519	80	1.17393	120	0.35982
1	33.3269	41	4.96392	81	1.13604	121	0.35042
2	31.5635	42	4.76253	82	1.09958	122	0.3413
3	29.9058	43	4.57050	83	1.06448	123	0.33246
4	28.3459	44	4.38736	84	1.03069	124	0.32390
5	26.8778	45	4.21263	85	0.99815	125	0.31559
6	25.4954	46	4.04589	86	0.96681	126	0.30754
7	24.1932	47	3.88673	87	0.93662	127	0.29974
8	22.5662	48	3.73476	88	0.90753	128	0.29216
9	21.8094	49	3.58962	89	0.87950	129	0.28482
10	20.7184	50	3.45097	90	0.85248	130	0.27770
11	19.6891	51	3.31847	91	0.82643	131	0.27078
12	18.7177	52	3.19183	92	0.80132	132	0.26408
13	17.8005	53	3.07075	93	0.77709	133	0.25757
14	16.9341	54	2.95896	94	0.75373	134	0.25125
15	16.1156	55	2.84421	95	0.73119	135	0.24512
16	15.3418	56	2.73823	96	0.70944	136	0.23916
17	14.6181	57	2.63682	97	0.68844	137	0.23338
18	13.9180	58	2.53973	98	0.66818	138	0.22776
19	13.2631	59	2.44677	99	0.64862	139	0.22231

APPENDIX 2

Compressor Discharge Temperature Sensor Resistance Value Table, B=3950K

℃	K Ohm	℃	K Ohm	℃	K Ohm	℃	K Ohm
-20	542.7	20	68.66	60	13.59	100	3.702
-19	511.9	21	65.62	61	13.11	101	3.595
-18	483	22	62.73	62	12.65	102	3.492
-17	455.9	23	59.98	63	12.21	103	3.392
-16	430.5	24	57.37	64	11.79	104	3.296
-15	406.7	25	54.89	65	11.38	105	3.203
-14	384.3	26	52.53	66	10.99	106	3.113
-13	363.3	27	50.28	67	10.61	107	3.025
-12	343.6	28	48.14	68	10.25	108	2.941
-11	325.1	29	46.11	69	9.902	109	2.86
-10	307.7	30	44.17	70	9.569	110	2.781
-9	291.3	31	42.33	71	9.248	111	2.704
-8	275.9	32	40.57	72	8.94	112	2.63
-7	261.4	33	38.89	73	8.643	113	2.559
-6	247.8	34	37.3	74	8.358	114	2.489
-5	234.9	35	35.78	75	8.084	115	2.422
-4	222.8	36	34.32	76	7.82	116	2.357
-3	211.4	37	32.94	77	7.566	117	2.294
-2	200.7	38	31.62	78	7.321	118	2.233
-1	190.5	39	30.36	79	7.086	119	2.174
0	180.9	40	29.15	80	6.859	120	2.117
1	171.9	41	28	81	6.641	121	2.061
2	163.3	42	26.9	82	6.43	122	2.007
3	155.2	43	25.86	83	6.228	123	1.955
4	147.6	44	24.85	84	6.033	124	1.905
5	140.4	45	23.89	85	5.844	125	1.856
6	133.5	46	22.89	86	5.663	126	1.808
7	127.1	47	22.1	87	5.488	127	1.762
8	121	48	21.26	88	5.32	128	1.717
9	115.2	49	20.46	89	5.157	129	1.674
10	109.8	50	19.69	90	5	130	1.632
11	104.6	51	18.96	91	4.849		
12	99.69	52	18.26	92	4.703		
13	95.05	53	17.58	93	4.562		
14	90.66	54	16.94	94	4.426		
15	86.49	55	16.32	95	4.294		
16	82.54	56	15.73	96	4.167		
17	78.79	57	15.16	97	4.045		
18	75.24	58	14.62	98	3.927		
19	71.86	59	14.09	99	3.812		